

ENGINEEREDWOOD

AUTUMN 2024

Journal

IN MEMORIAM

Engineered Wood
Journal, 1998-2024

PAGE 10

SEE YOU IN SAN ANTONIO

APA Annual Meeting
and EWTA Info Fair
Preview

PAGE 18

BUSINESS OUTLOOK

More of the Same
in 2025?

PAGE 40



DON'T LET WOOD'S NATURAL ENEMIES WIN.

Protect your engineered
wood against

- termites
- mold
- fungal decay

LEARN MORE ABOUT
ENHANCING THE
PERFORMANCE
OF ENGINEERED WOOD

WolmanizedWood.com

Permatek®

FrameGuard®

LotusPro™

ENGINEEREDWOOD

Journal

ENGINEERED WOOD JOURNAL

VOLUME 28, NO. 2, AUTUMN 2024

Engineered Wood Journal is published by the Engineered Wood Technology Association, a related nonprofit organization of APA – The Engineered Wood Association. The Journal is produced for and distributed free of charge to North American engineered wood product manufacturers; their equipment, product and service suppliers; and other industry stakeholders. © 2024 Engineered Wood Technology Association. All rights reserved. Reproduction in whole or in part without written permission is prohibited. The views and opinions of contributing authors are not necessarily those of EWTA, APA, their members or advertisers.

ENGINEERED WOOD TECHNOLOGY ASSOCIATION

7011 South 19th Street
Tacoma, WA 98466
Phone: 253-620-7483
www.engineeredwood.org

PROGRAM MANAGER
LaDauna Wilson

TECHNICAL SERVICES DIRECTOR
BJ Yeh



About the cover photo:

The *Engineered Wood Journal* delivered industry news and developments as a printed magazine from 1998 to 2019 before transitioning to an exclusively digital format in 2020. See story and more photos, page 10.



STRENGTH THROUGH CONNECTIONS

DEPARTMENTS

PRIMELINES 5

INDUSTRY AND ASSOCIATION CONNECTIONS. 6

MEMBER CONNECTIONS 86

READER SERVICES 92

ADVERTISER CONNECTIONS 93

FEATURES

IN MEMORIAM
Engineered Wood Journal, 1998-2024 10

SEE YOU IN SAN ANTONIO
APA Annual Meeting and EWTA Info Fair Preview . . . 18

MARKET OUTLOOK
More of the Same in 2025? 32

STRUCTURAL URETHANE ADHESIVES TO ENHANCE ENGINEERED WOOD & MASS TIMBER PRODUCTS 38

INNOVATION IN SAFETY
2023 Award Winners 42

INTENTIONAL CONVERSATIONS
One Habit That Will Transform Your Leadership Skills 46

2024 SUPPLIER AWARDS
Annual Recognition for Innovation and Excellence. . 48

2024 EWTA Member Directory
Consulting and Services 55
Equipment and Tooling 59
Materials and Supplies 77

Final Frame 94

FULLY AUTOMATED CLT LINES

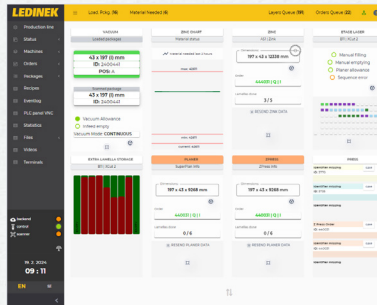

X-LAM Manager

Simple control of CLT production

- ➔ One-operator solutions for complex production
- ➔ Fully automated production process
- ➔ Production order management
- ➔ Real-time ERP feedback
- ➔ Centralized control
- ➔ Custom built

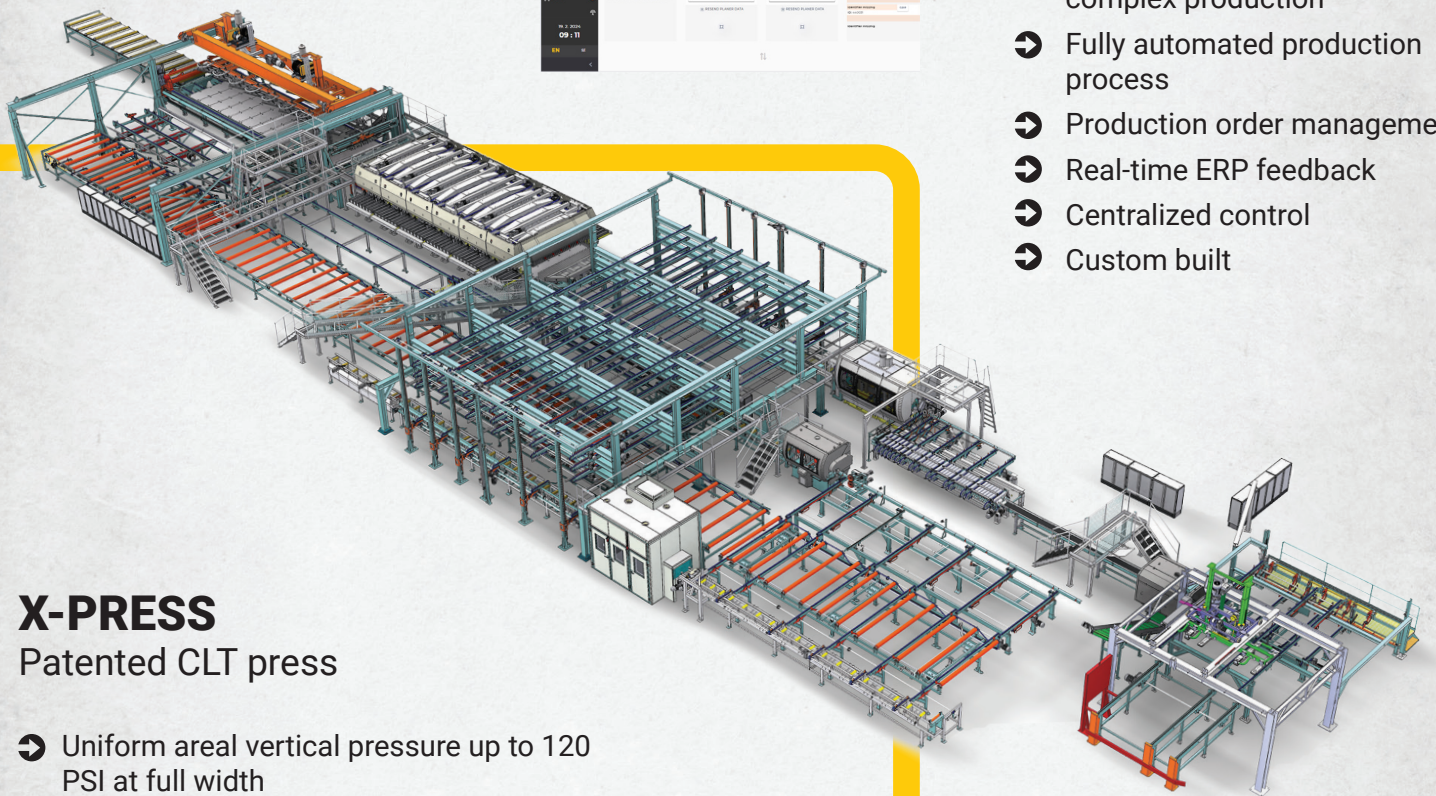

X-PRESS

Patented CLT press

- ➔ Uniform areal vertical pressure up to 120 PSI at full width
- ➔ Pneumatically driven pressure buildup through flat tubes
- ➔ High productivity through automatic sequence control
- ➔ Stack compression in length- and crosswise direction
- ➔ Perfected 3rd gen, low energy use, low maintenance



BOARD OF TRUSTEES

Doug Asano, Chair
Roseburg Forest Products Co.

Chris Degnan, Vice Chair
Weyerhaeuser

Mark Tibbetts, President
APA – The Engineered Wood Association

Rich Babcock
Rosboro

John Beers III
Georgia-Pacific Wood Products LLC

Ashlee Cribb
PotlatchDeltic Corporation

Jim Enright
Pacific Woodtech Corporation

Richie LeBlanc
Hunt Forest Products, LLC

Roy O. Martin III
Martin Sustainable Resources L.L.C.

Jimmy Mason
Louisiana-Pacific Corporation

John Murphy, Jr.
Murphy Company

Pino Pucci
Tolko Industries Ltd.

Chris Seymour
Boise Cascade Company

Matt Tobin
West Fraser

Stephen Williams, Finance Committee Chair
Western Forest Products Inc.

EWTA ADVISORY COMMITTEE

Chris Degnan, Chair
Weyerhaeuser

Chris Van Ackeren, Vice Chair
USNR

Bret Knudsen
Arclin – Performance Applied

Tom Stewart
Bostik

Colin Folco
Dieffenbacher

Rodney Schwartz
Dürr MEGTEC, LLC

Christie Cordova
Georgia-Pacific Wood Products, LLC

Karl Aicher
Grenzebach Corporation

Mark Aucoin
Hexion Inc.

Kyle Galligan
Hunt, Guillot & Associates

Kevin Carpenter
Louisiana-Pacific Corporation

Trevor Wendt
Raute

Bob Hadden
Samuel Strapping Systems

Mike Cook
SparTek Industries

Kevin Blau
Tolko Industries Ltd.

Mike Crondahl
Westmill Industries USA Corp.

Rebecca Tracy
Willamette Valley Company

LaDauna Wilson
EWTA Program Manager

BJ Yeh
APA - The Engineered Wood Association

IN THIS ISSUE . . .

Welcome to the final edition of the *Engineered Wood Journal*. In this issue, we reflect on 26 years of shared industry news and the magazine's rich history, featuring insights from Jack Merry, the first editor of the *Engineered Wood Journal* and retired APA industry communications director. Flip to page 10 for a retrospective look at the magazine's journey, covering issues from 1998 through 2024.

Mark your calendars! The APA Annual Meeting and EWTA Info Fair is happening earlier this year, from September 28 to October 1, 2024, at the JW Marriott San Antonio Hill Country Resort & Spa. This year, APA and EWTA members will gather in San Antonio, Texas, for four days filled with networking, industry meetings, and exciting sporting events—including a golf tournament, the return of the clay pigeon shoot, and the debut of a pickleball tournament. For a preview of the planned events and a list of Info Fair sponsors and exhibitors, turn to page 18. Full details are also available on the APA and EWTA events website at www.apa-ewta-events.org.

In addition to industry, association, and member news featured in the following pages, be sure to explore the following:

Turn to page 32 for APA Market Research Director Joe Elling's projections on the 2025 Market Outlook. Then, head to page 38 to discover how urethane structural adhesive systems are advancing mass timber and engineered wood products.

For 16 years, the Safety and Health Advisory Committee (SHAC) has been at the forefront of revitalizing safety efforts. By promoting and recognizing operational excellence, SHAC has significantly contributed to reducing injury and illness rates across our industry. Turn to page 42 to discover more about the program and find out which 20 facilities from eight APA companies have been honored with awards in various categories. Then, continue to page 46, where a safety manager from an APA member company reveals one key habit that can transform leadership skills.

Speaking of awards, each fall APA members are invited to select the winners of the annual EWTA Supplier of the Year and Innovation of the Year awards. For 2024, the Innovation of the Year will be chosen from seven entries submitted by EWTA members, showcasing their latest technology, products, or services. Turn to page 48 to learn more about these innovations. If you're an APA member, don't forget to cast your vote!

Need contact information for industry suppliers? Check out the updated EWTA member directory starting on page 45. It includes company details and contact information for all EWTA members and highlights the sponsors for the upcoming Info Fair.

In closing, I want to extend a special thank you to those who have been with us from the beginning through to the end—namely, Jack Merry, Terry Kerwood, Melinda Lilley, Sheila Cain, Mike Martin, and Kim Sivertsen. I also want to express my gratitude to all the advertisers, APA and EWTA members, staff, writers, artists, and subscribers of the *Engineered Wood Journal* over the past 26 years. We couldn't have achieved this success without each of you.

It's been a pleasure to be part of this magazine, and while I'm sad to see it come to an end, I'm proud of all that we've accomplished together.



LaDauna Wilson
EWTA Program Manager
ladauna.wilson@apawood.org
ewta@engineeredwood.org



SMALL BUILDING, BIG EDUCATIONAL OPPORTUNITIES

Engineering Students Wow at Wood Design Competition

Some designed playhouses. One team created a “barndominium.” And at least one erected a tiny pub. Those are just three entry examples from the 2024 Timber-Strong Design BuildSM competition, which took place nationwide at college campuses this spring. Since 2019, the contest has given engineering students the opportunity to gain hands-on experience with wood design and construction. It also teaches teamwork and planning and demonstrates the value of prefabrication. What began as a giant Jenga contest more than seven years ago now attracts hundreds of

participating students and over a thousand spectators. This year’s competition included 464 students from 46 schools.

APA – The Engineered Wood Association, the American Wood Council and Simpson Strong-Tie partner with the American Society of Civil Engineers to carry out the competition.

This year’s winners included teams from Michigan, Indiana, Florida, Colorado, Utah, Texas, California and Puerto Rico.



Continues on next page.

Participating students were tasked with drafting and building an attractive, sustainable and durable two-story wood-frame structure. Among its requirements:

- Maximum height of 12 feet.
- Openings for at least three windows (one per wall) on the first floor.
- A windowless first-floor wall must have a door.
- The second level must have a floor opening.
- The second floor must be cantilevered 12 inches in one direction.
- The second level must have framed openings for four windows (one per wall).

Teams prepare project budgets and adhere to Occupational Safety and Health Administration safety guidelines and the model building code. Each structure is required to show a continuous load path for both gravity and wind loads. Mirroring real-world conditions, each team had to navigate the submittal, requests-for-information and change order processes.

John Wilkinson, head judge for the Eastern Great Lakes region, said the contest allowed students to collaborate and use their skills in structural calculations, building information modeling and physical construction. And it was good practice for their future careers, he added.

“This competition is a great example of how the interactions between designers and instructors in the field (go),” Wilkinson said.

Aidan Zydiak was a captain for the University of Florida’s design team. Zydiak said the competition gave him the chance to learn about BIM software for the first time.

“I feel that using the software was the most applicable part of the project to my career in the future,” he said. “I also enjoyed cutting the wood and building the structure. Bringing the design to physical reality was satisfying.”

The competition’s time constraints were also important. Aleeta Dene, an Engineered Wood

Continues on next page.

THIS YEAR’S WINNERS WERE:

Eastern Great Lakes Symposium Winners

First place: Michigan Technological University

Second place: Cleveland State University

BIM category: Cleveland State University

Indiana-Kentucky Symposium Winners

First place: Purdue University-West Lafayette

BIM category: Purdue University-West Lafayette

Southeast Symposium Winners

First place: Florida Agricultural and Mechanical University-Florida State University

Second place: University of Puerto Rico-Mayaguez

Third place: Florida International University

BIM category: University of North Florida

Region 6 Symposium Winners

First place: LeTourneau University

Second place: University of Texas-Arlington

Third place: University of Texas-Tyler

BIM category: LeTourneau University

Rocky Mountain Symposium Winners

First place: Colorado School of Mines

Second place: South Dakota School of Mines and Technology

BIM category: South Dakota School of Mines and Technology

Intermountain Southwest Symposium Winners

First place: Utah State University

Second place: Northern Arizona University

Third place: Boise State University

BIM category: Brigham Young University-Idaho

Pacific Southwest Symposium Winners

First place: California Polytechnic State University-San Luis Obispo

Second place: University of California-Irvine

Third place: University of California-Los Angeles

BIM category: California State University-Long Beach

For more information on the Timber-Strong Design Build competition, visit:

• Timber-Strong Design Build Competitions - APA – The Engineered Wood Association

• Timber-Strong Design Build Competition | ASCE



Student-led teams have 90 minutes to erect attractive, durable, engineered wood structures.

Specialist in APA's Field Services Division, said that although teams had 90 minutes to build their structures, finishing first wasn't necessarily a goal.

"The most successful teams take it apart and put it together multiple times" to ensure the structure was built right, she said.

COMING IN 2025

In the summer of 2025, California Polytechnic State University – San Luis Obispo will be the first American Society of Civil Engineers National Competition host to welcome Timber-Strong Design Build competitors nationwide. This event will mark the first time the event will include concrete, steel and wood. The national event will consist of Concrete Canoe, Steel Bridge and Timber-Strong Design Build. APA will continue to be a co-sponsor of the Timber-Strong Design Build Competition.



- Planning and Development
- Engineering
- Project Management
- 3D/VR Design Capability
- Construction Coordination
- Process Improvements
- 3D Scanning/Reality Capture
- Drone Imagery



Hot Springs, AR • Cary, NC • Orono, ME • Richmond, BC • Rogers, AR
 MSECO.COM • 501-321-2276

CCMC Offers Product Listing Based on APA Product Reports

The Canadian Construction Materials Centre (CCMC), part of the National Research Council Canada, evaluates construction materials for use in Canada. CCMC recently announced a new product listing option for recognizing products manufactured to the Canadian national product standards, such as structural glued laminated timber (glulam) under

Continues on next page.

CSA O122, cross-laminated timber under ANSI/ APA PRG 320 (U.S. and Canada binational standard), and wood structural panels under CSA O325, O121, O151 or O153. This new option enables the use of a third-party certification, such as an APA Product Report. This new program can significantly reduce the time required to obtain a CCMC listing for commodity products.

Detailed information about this new option is available on their website. At this point, this option is not available for proprietary products that do not have a Canadian national product standard, such as prefabricated wood I-joists and structural composite lumber.

APA Achieves ISO/IEC 17020 and 17025 Accreditation from ANAB

On June 13, 2024, APA received ANSI National Accreditation Board (ANAB) accreditation for standards ISO/IEC 17020-2012—Conformity Assessment – Requirements for the Operation of Various Types of Bodies Performing Inspection (ANAB AI-3950) and ISO/IEC 17025-2017—General Requirements for the Competence of Testing and Calibration Laboratories (ANAB AT-3949).

RETIREMENTS

Dr. Borjen Yeh, P.E., PhD,
APA Director,
Technical Services



Dr. Borjen Yeh, P.E., PhD

Dr. Yeh has been with APA for more than 34 years, serving as director of the Technical Services Division since 2003. He is currently the chair of the ASTM D07.02 Subcommittee on Lumber and Engineered Wood Products and a member of several technical committees and professional societies in the U.S., Canada and International Standards Organization. He is the secretariat for ANSI/APA Standards Committees on Structural Glued Laminated Timber, Structural Insulated Panels, Engineered Wood Siding, Engineered Wood Rim Boards and Cross Laminated Timber. He was the recipient of the L.J. Markwardt Award of ASTM in 2006 and the ASTM International's Award of Merit in 2013. Dr. Yeh earned his M.S. at Iowa State University and Ph.D. at University of California, Berkeley. He is also a registered professional engineer in the state of

Washington. Thank you, BJ, for your contributions and dedication to APA, its members and the engineered wood industry. Congratulations on your retirement.

Brian Delbrueck, Arxada

Brian Delbrueck, Associate Director Sales, Canada, Western U.S., & Wood Specialties for Arxada, recently retired after nearly 40 years in the industry. Brian started his career at Rentokil in 1987



Brian Delbrueck

and continued with CSI when they bought Rentokil. Brian dedicated his career to the advancement and promotion of wood protection products. He was active within the industry, serving on the Supplier Technology Committee for WDMA, on the Board of Directors for WWPI for more than 10 years, on the WPC Technical Committee, on the EWTA Advisory Committee and on the Composites Committee for AWPA. Thank you, Brian, for your service to the industry, and congratulations on your retirement.

IN MEMORIAM

Engineered Wood Journal

1998-2024

by Jack Merry



Receiving word recently that this would be the last issue of the *Engineered Wood Journal* was a bit like unexpectedly coming across the obituary of an old friend from a bygone era.

I haven't been associated with the *Journal* for more than a decade now, but I was there at its birth, in 1998, and for several years thereafter as editor while it matured and evolved. When Engineered Wood Technology Association (EWTA) Program Manager LaDauna Wilson invited me to share a few thoughts on the life and times of the magazine, I was honored to oblige.

The idea for this magazine was actually second in line to another publication that APA – The Engineered Wood Association staff considered but then rejected. The first was for a publication targeted at construction market users and specifiers as a means to increase demand for APA member products. It would have fit nicely into APA's strategic marketing plan. However, after review of the human resource requirements, the publishing competition at the time, the

Continues on next page.

financial risks and benefits, and other factors, the idea for such a venture was abandoned.

As chance would have it, a company called Naylor Publications, which specialized in publishing magazines for nonprofit organizations, contacted APA at just about that same time. It was a fortuitous introduction because there had been another idea at APA for a magazine that would be aimed not at the market, but at the APA membership, supported by advertising purchased by the industry's product, equipment and service providers. Naylor had clients with similar publications, and the company was deemed a promising publishing partner.

A proposal was drafted and presented to APA President Dave Rogoway, who gave it an enthusiastic thumbs up as a means to advance industry communication goals and enhance recognition of APA

“A proposal was drafted and presented to APA President Dave Rogoway, who gave it an enthusiastic thumbs up as a means to advance industry communication goals and enhance recognition of APA as the leading voice of the industry.”

as the leading voice of the industry. As noted in the Volume I, Number I issue of the magazine's PrimeLines column, the *Journal* would strive to be “a unique and valuable tool for exchanging information and improving communication among engineered wood product manufacturers; product, equipment and service suppliers; and others with a stake or interest in the engineered wood products industry, such as academia, consultants, analysts and trade media.”

That mission in practice, the column continued, would translate into articles on “processing trends and

innovations, research and development issues, marketing challenges and opportunities, technical developments, quality assurance, certification and regulatory developments, industry safety programs,” and more. By bringing manufacturers and suppliers closer together, it was believed the magazine might also aid efforts to more clearly define and strengthen the relationship between APA and its related nonprofit supplier organization, the Engineered Wood Research Foundation (EWRP), which was EWTA's predecessor.

The first issue, published in the fall of 1998, underscored the stated goals with articles on the

Continues on next page.



need for industry-academia wood science program partnerships, the purpose and importance of CORRIM (Consortium for Research on Renewable Industrial Materials), APA's newly introduced Quality Management System, the transformation of Georgia-Pacific Corporation's mill safety program, and the history and purpose of the Engineered Wood Research Foundation, among others.

The publishing agreement with Naylor had both benefits and drawbacks. On the benefits side, APA maintained complete editorial control while Naylor was responsible for graphic design, production, printing, advertising sales, and both hard copy mailing and online posting. That arrangement thus helped to conserve scarce APA human and financial resources. In addition, Naylor assumed all financial liability and APA even stood to earn modest revenue-

“Feature articles often sought to spotlight emerging trends and issues of importance to the industry...for example...lean manufacturing, wood product certification, e-commerce, corporate social responsibility, electronic learning and training, green building, employee retention, market threats and product performance.”

sharing income provided certain advertising thresholds were met.

The chief downside was that space for articles was limited under an advertising-to-editorial content formula. The revenue earned by APA also was indeed very modest based on the advertising that was able to be sold. However, since the primary motivation for the project was information exchange, not income, that limitation was not considered crucial.

Given that the *Journal* was one among many assignments within the APA industry communications function,

it was decided to start with just two issues per year, then reexamine the feasibility of increasing frequency based on industry reception, available human resources, and other APA priorities. As it happened, the spring and fall publication schedule was never revised.

Launching was no small task. A mailing list had to be developed from various sources. A design had to be crafted and approved. Story ideas had to be created and contributing writers secured. A media kit had to be developed. And

Continues on next page.



advertising, editorial, printing and distribution schedules had to be established. But it all came together, and in the fall of 1998 the first issue of the magazine arrived at the offices of industry CEOs and senior executives, mill managers, superintendents, technical directors, quality control supervisors, and sales and marketing managers, as well as key supplier industry professionals and other industry stakeholders.

That premier issue of the magazine, as is typical with highly celebrated first issues, had a higher page count, 64, than would prove to be the average over the next 10 years. Most issues ran between 32 and 44 pages, with the fall issue always including an APA annual meeting preview that increased the page count.

Feature articles often sought to spotlight emerging trends and issues of importance to the industry. Some of those,



The *Journal* often spotlighted major trends and developments, such as this Fall 1999 issue article on industry mergers, acquisitions, consolidation and restructuring.

for example, were process efficiency methodologies, such as lean manufacturing, wood product certification, e-commerce, corporate social responsibility, electronic learning and training, green building, employee retention, market threats and product performance. Submissions from industry suppliers on manufacturing technologies, solutions and

innovations that were regularly recruited and published.

The magazine from time to time would follow human interest storylines as well, such as the Spring 2003 profile of longtime industry executive Paul Ehinger, the Spring 2005 feature on the genesis of the Thunderbird plywood sailboat design, and the Spring 2010 article on artist Ken Brauner, whose timber

Continues on next page.

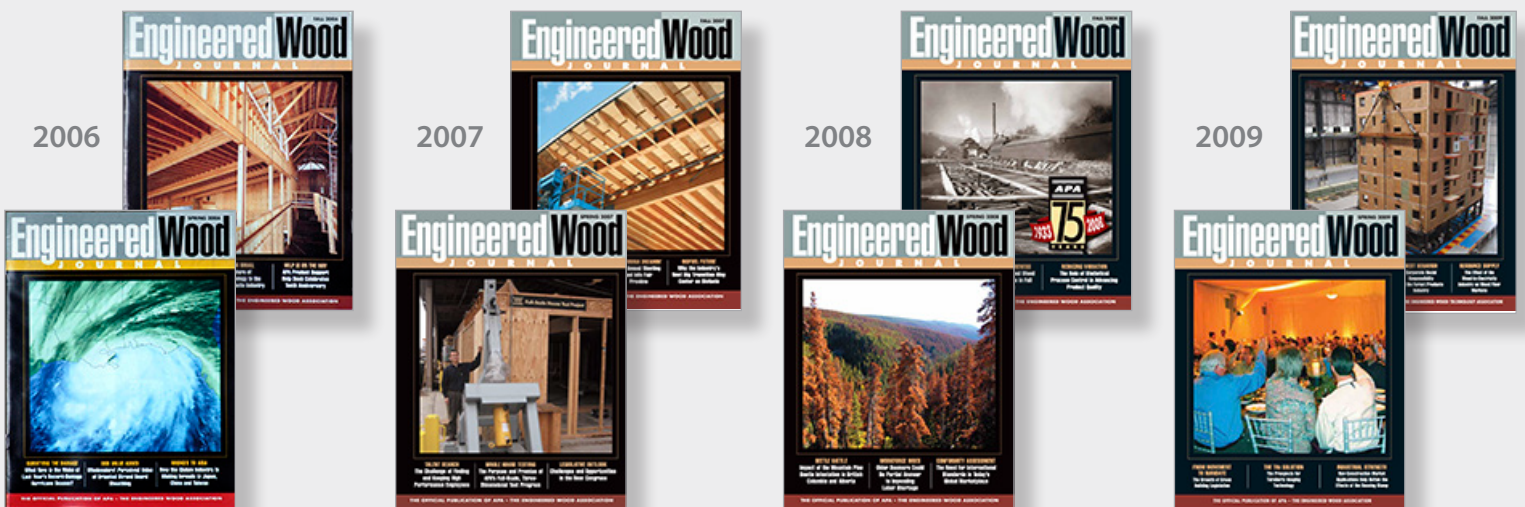

industry paintings have hung for decades in offices, conference rooms, universities and museums around the country.

In 2008, the fall issue of the magazine included a 36-page supplement commemorating the 75th anniversary of APA, which was founded in 1933 as the Douglas Fir Plywood Association. The special anniversary edition featured numerous synopses of association and industry milestones, including, for example, registration of industrywide trademarks in 1938, the birth of the Southern pine plywood industry in the early 1960s, the opening of APA's new research laboratory in 1969, celebration of APA's 50th anniversary in 1983, and creation in 1991 of American Wood Systems, a related APA nonprofit organization charged with providing services to non-panel structural engineered wood product manufacturers.

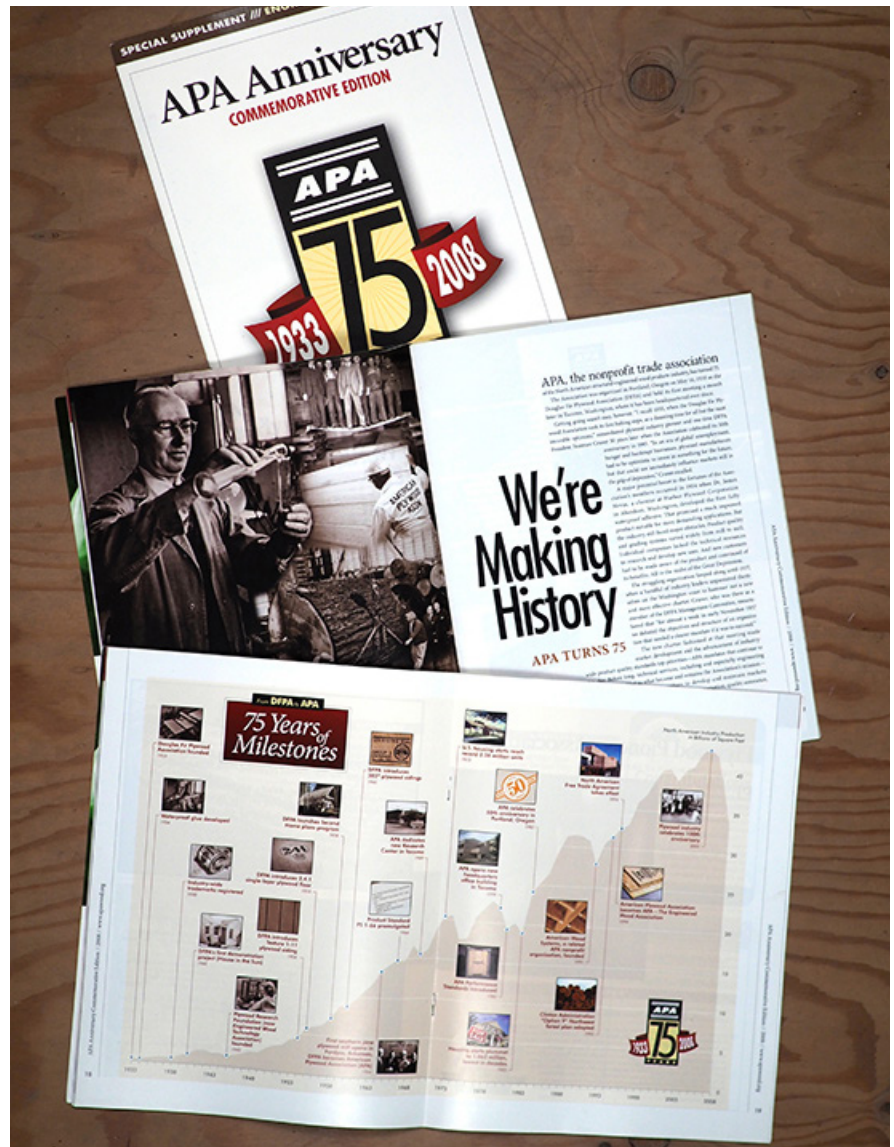

A special APA anniversary edition of the *Journal* was published in 2008 to commemorate the Association's 75-year history.

Continues on next page.





This Spring 2005 feature story covered a 1950s Association-sponsored plywood sailboat design competition as part of the magazine's 100-year industry anniversary celebration.

A major milestone in the history of the *Journal* was its near-death experience in 2009. The housing market crash and subsequent Great Recession forced APA, as with the entire economy, to downsize, consolidate and reorganize. Among the many casualties at APA was the industry communications function, under which the magazine fell. Rather than let the *Journal* die, however, a plan was devised to

transfer publication responsibility from APA to EWTA. The supplier organization would contract with this author (who was then no longer with APA) for continued editorial services, and Naylor would continue in its existing capacity. APA President Dennis Hardman liked and blessed the idea, and EWTA Managing Director Terry Kerwood likewise endorsed it.

The spring 2009 issue was the last to be published under the auspices of APA (until the spring of 2020), and its page count, just 28, reflected the significant contraction of the economy and the industry. Conditions gradually improved, however, and the magazine before long was regaining advertisers and increasing its page count.

In 2011, a financial analysis was conducted to determine the feasibility of bringing all aspects of the publication venture, including advertising sales, printing and distribution, under EWTA in-house control rather than renewing the contract with Naylor. The pro forma numbers looked promising, and a proposal to go forward with the idea was approved by the EWTA Advisory Committee. The first issue under the new regime grew by 16 pages, and both advertising sales and project net revenue continued to climb over the next several

Continues on next page.

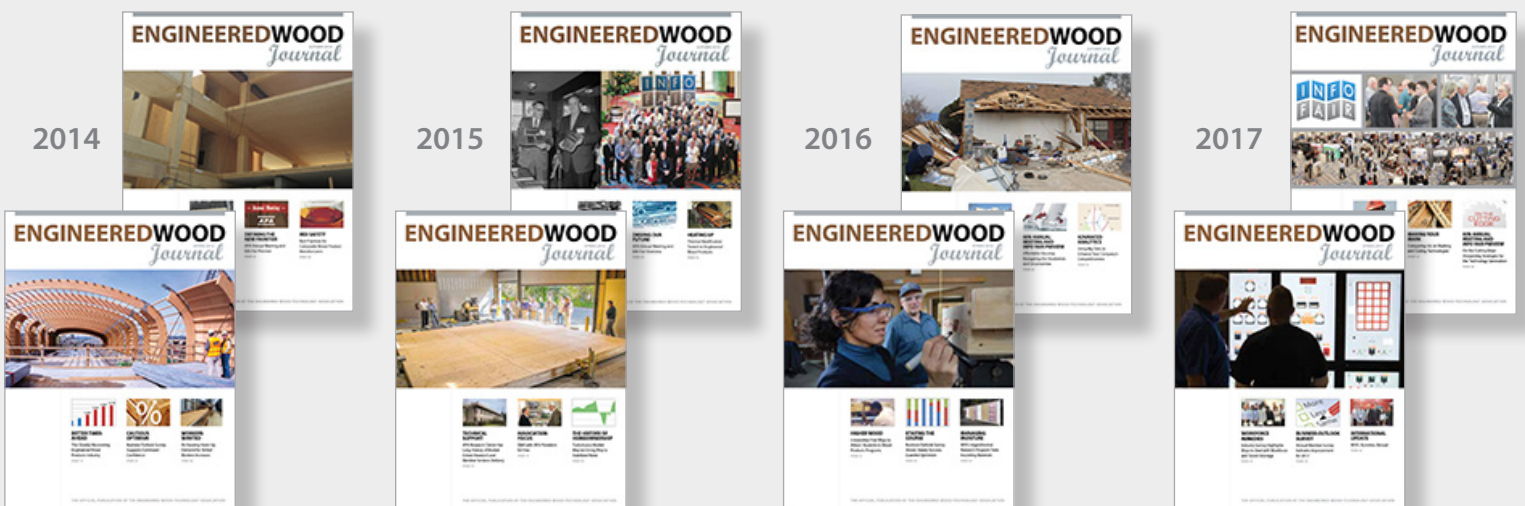

years, contributing significantly to EWTA non-dues income.

The next chapter in the life of the *Journal*, and a personal milestone for me, began with my retiring as editor after 14 years at the helm. My last issue, published in the fall of 2012, announced Sheila Cain as my successor, who would remain in the position for the next seven years.

Publication of the *Journal*, together with all other functions of the Engineered Wood Technology Association, was transferred back to APA in 2019. Soon thereafter, as the entire world remembers, the COVID-19 pandemic struck. The lockdown of society and shutdown of the economy would have deep and long-lasting financial impacts

on everything and everyone, including, now, the *Engineered Wood Journal*. This Fall 2024 issue will be the last—yet another casualty, it seems, of the pandemic.

No telling of the *Journal's* quarter-century life story would be complete without citing the contributions of numerous individuals associated with the venture over the years. Among these must be counted former APA Presidents Dave Rogoway and Dennis Hardman, who in the first instance greenlighted the project at its inception and in the second gave it new life when it might otherwise have perished during the Great Recession. Former EWTA Managing Director Terry Kerwood welcomed the magazine under the EWTA flag when APA had to cut it loose. Melinda Lilley was absolutely tireless selling advertising in her role as EWTA member services director (and

Continues on next page.



University wood science education programs were the topic of this Fall 2019 feature. The *Journal* had a long association with academia, which frequently contributed articles on a variety of education, processing technology and business management topics.



as overall industry cheerleader). Mike Martin, longtime APA art director (and designer of this final issue) provided expert graphic arts support during many of the years that EWTA produced the magazine in-house. Maria Tomal (Johnsen) and Kim Sivertsen were, in succession, incredibly helpful editorial assistants who in too many ways to count came to my rescue. Sheila Cain, a clear thinker, lively writer and quick study, proved in my view to be my ideal successor as editor. And although we did not work together on the *Journal* (but were colleagues at APA previously), obvious credit is due LaDauna Wilson, who in her capacity as EWTA program manager and de facto *Journal* editor successfully navigated the project through the impossibly challenging pandemic-era times.

Special mention also must be made of the dozens of EWTA member company suppliers who

for 26 years made the magazine possible through the purchase of advertising. Many also contributed highly valued articles on manufacturing topics over the life of the publication.

Some might argue that communication vehicles like the *Journal* provide a value proposition worthy of some level of subsidy—not unlike, for example, newsletters, annual reports, or other customer, client and stakeholder communications. Priorities are many, of course, and resources limited, so hard choices are always difficult and inevitable.

Be that as it may, the greatest value of the *Journal*—now that its publication life is ending—may well be its legacy. As a quarter-century chronicle of the industry, the magazine as a digitized archive can now and forever provide a fascinating and unique perspective on the challenges, trends, priorities and achievements of the industry

during the period it covered, as well as a history of industry leaders, events and company milestones. It might also, one hopes, help preserve a sense of institutional memory and industry pride in an era where such qualities seem to be of declining currency.

In the final analysis and as a final commentary, I think it can be said of the *Engineered Wood Journal*: it had a good life. 



Jack Merry (jfmerrycomm@gmail.com) retired as APA industry communications director in 2009 and was editor of the *Engineered Wood Journal* from its inception in 1998 until 2012.



“...the greatest value of the *Journal*—now that its publication life is ending—may well be its legacy.”

APA ANNUAL MEETING AND EWTA INFO FAIR PREVIEW

SEPT. 28 – OCT. 1, 2024

JW MARRIOTT SAN ANTONIO HILL COUNTRY
RESORT & SPA, SAN ANTONIO, TEXAS





APA | EWTA



ANNUAL MEETING
& Info Fair

This year's APA Annual Meeting and EWTA Info Fair is scheduled for Sept. 28 – Oct. 1 at the JW Marriott San Antonio Hill Country Resort & Spa. The resort is nestled amidst 600 acres of oak-covered hills near San Antonio, Texas.

The annual event gathers APA and EWTA members from across the engineered wood industry to exchange ideas and insights, reflect on the industry's accomplishments and challenges, and explore future opportunities. The three-day event includes presentations, discussions, networking opportunities and sporting events.

Several advisory, marketing and subcommittee meetings will initiate the event on Saturday. The day concludes with a welcome reception for APA and EWTA members and meeting attendees.

Sunday is packed with recreation and networking opportunities:

- **Mike St. John Memorial Golf Tournament:** Held at JW Marriott's Canyons Course, the tournament offers dramatic elevation changes and a course woven within the unique topography of the surrounding Texas Hill Country.
- **Ole Sorensen Memorial Pickleball Tournament:** Reflecting the latest trend of swapping tennis rackets for pickleball paddles, this informal tournament will take place at the JW Marriott Courts.
- **Cripple Coot Shoot Sporting Clays Tournament:** This popular event returns after a 2-year hiatus and will be held at the Joshua Creek Ranch, a premier hunting lodge and Texas Hill Country Sporting Resort.
- **2024 Info Fair Supplier Exhibit and EWTA-Hosted Reception:** Opening at 4:30 p.m., this event features 76 EWTA exhibitors and sponsors, inviting members and guests to gather and reconnect with industry colleagues and friends.

Continues on next page.

Monday's General Session will include a panel of three A.I. experts who will discuss the benefits of using artificial intelligence in the wood products industry. This panel includes:



Martin Fleming



Penelope Brown



Juho Einovaara

- **Martin Fleming**, a Massachusetts Institute of Technology research scientist and artificial intelligence expert.
- **Penelope Brown** of the National Association of Manufacturers. Brown is the managing editor of Manufacturing Leadership Journal.
- **Juho Einovaara**, an AFRY management consultant who specializes in the wood products industry.

The session will also feature the “State of the Association/Industry address by APA Board of Trustees Chair Doug Asano, along with the presentation of the Bronson J. Lewis Award. After the General Session, attendees will have the opportunity to meet with the panelists in a more informal setting for further discussion and Q&A.



Doug Asano

Following the General Session, a Safety & Health Workshop features a keynote address by Eric Giguere,

who relays his focus on safety through the topic “The Buried Truth Uncovered.” Additional safety and best practices presentations will be provided by APA and EWTA industry leaders.

Dan Semsak, the Marketing Advisory Committee chair, will start the afternoon meetings with a brief MAC update, followed by APA's Market Research Director Joe Elling's five-year market outlook. The meeting will conclude with Matt Brown, APA's director of energy policy and code, reporting on APA's newly developed energy and resiliency policies. His presentation will cover the current impact of these policies on member products and outline APA's strategic course of action moving forward.

Info Fair will resume from noon to 1:30 p.m. on Monday, and again from 5-6:45 p.m. with a reception that will kick off the evening's 7:00 p.m. Chairman's Dinner and APA Safety Awards Recognition. APA members who have made significant advancements in mill safety will be honored, along with winners of EWTA's Supplier of the Year and Innovation Award program.

See the schedule of events on the right for the complete meeting agenda.

We are excited to see you in San Antonio!

2025 APA ANNUAL MEETING AND EWTA INFO FAIR

SAVE THE DATE!

OCTOBER 4-7, 2025

SHERATON GRAND AT WILD HORSE PASS, PHOENIX, AZ



AGENDA

Go to www.apa-ewta-events.org for the latest updates and agenda.

SATURDAY, SEPT. 28

8:30 a.m. – 5:30 p.m.	Registration desk open
10:30 – 11:30 a.m.	International Market Subcommittee (APA members only)
10:30 – 11:30 a.m.	EWTA Advisory Committee
1:00 – 1:30 p.m.	Glulam/CLT Management Committee (APA members only)
1:45 – 2:30 p.m.	Joint Glulam/CLT and I-Joist/SCL Management Committee (APA members only)
2:30 – 3:00 p.m.	I-Joist/SCL Management Committee (APA members only)
4 – 5:00 p.m.	Industrial Market Subcommittee (APA members only)
5:00 – 6:30 p.m.	Welcome Reception

SUNDAY, SEPT. 29

7:15 a.m. – 2 p.m.	Cripple Coot Shoot, Joshua Creek Ranch
8:30 a.m. – 1:30 p.m.	Mike St. John Memorial Golf Tournament, JW Marriott Canyons Course
9 a.m. – Noon	Ole Sorensen Memorial Pickleball Tournament, JW Marriott Courts
11 a.m. – 5 p.m.	Registration desk open
3:00 – 4:30 p.m.	Nonresidential Market Subcommittee (APA members only)
4:30 – 6:30 p.m.	Info Fair Welcome and Reception

MONDAY, SEPT. 30

7 – 8:30 a.m.	Buffet Breakfast
8:00 a.m. – 4 p.m.	Registration desk open
8:30 – 10:15 a.m.	General Session
10:30 – 11:30 a.m.	Roundtable – Follow-up to General Session
10:30 a.m. – Noon	Residential Market Subcommittee (APA members only)
10:30 a.m. – 4 p.m.	Safety & Health Workshop
Noon – 1:30 p.m.	Info Fair and Lunch
1 – 3 p.m.	Marketing Advisory Committee
5:00 – 6:45 p.m.	Info Fair and Reception
7 – 9 p.m.	Chairman's Dinner & Safety Awards Recognition

DIAMOND SPONSORS —



Matthews Marking Systems™

meinan®



USNIR



WANHUA

Thank You

PLATINUM SPONSORS





Fagus  GreCon

 **NESTEC**
Smart Solutions for Clean Air

 **SWEEED**[®]
Machinery | Innovation | Solutions

 *Taihei*

 **WESTMILL**[™]
INDUSTRIES

WVCO

Thank You

GOLD SPONSORS



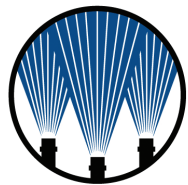

Spraying Systems Co.[®]



Thank You

SILVER SPONSORS



Thank You

GOLF SPONSORS



Thank You

PICKLEBALL SPONSORS



Thank You

COOT SHOOT SPONSORS



Thank You

EXHIBITORS

EXHIBITORS

- 511** AFRY Management Consulting
- 310** Altec Integrated Solutions Ltd.
- 215** Arclin - Performance Applied
- 111** Argos Solutions LLC
- 514** Bakelite Synthetics
- 504** BASF - We create chemistry
- 412** Biele USA LLC
- 103** Biomass Engineering & Equipment - Veneer Services, LLC
- 205** BMI Contractors, Inc.
- 400** Bostik, Inc.
- 305** Brunette Machinery Company Inc.
- 213** Chem-Trend LP
- *** Coil Manufacturing, Ltd.
- 405** Con-Vey
- 210** COSTA Sanders LLC
- 201** Dieffenbacher
- *** Dominion Chemical Company, Inc.
- 115** DO2 Industriel
- 300** Dürr Systems, Inc.
- 403** Electronic Wood Systems, N.A.
- *** Elite Automation
- 212** Evergreen Engineering, Inc.
- 509** Fagus GreCon, Inc.
- 105** Flamex
- 600** Franklin Adhesives & Polymer
- 202** FROMM Packaging Systems

EXHIBITORS

- *** Fusoni
- 602** Globe Machine Mfg. Co.
- 314** Grenzebach Corporation
- 311** Hansen-Rice, Inc.
- 499** Hashimoto Denki Co., Ltd.
- 313** Henkel
- 510** Hexion Inc.
- *** Hunt, Guillot & Associates LLC
- *** Huntsman Polyurethanes
- 203** IBC, International Bar Coding Systems & Consulting Inc.
- 303** IMAL-PAL Group
- 503** IMEAS Inc.
- 415** IPCO
- 513** Itipack Systems
- 500** KADANT Carmanah Design
- 501** Knight Material Technologies
- 606** LDX Solutions
- *** Ledinek
- 113** LIMAB North America
- 301** Matthews Marking Systems
- 410** Meinan Machinery Works, Inc.
- 608** Mill Machinery LLC
- 302** Munzing
- 304** NESTEC, Inc.
- 402** Nicholson Manufacturing Ltd.
- 502** Panel World Magazine / Hatton-Brown Publishers, Inc.

EXHIBITORS

- *** Paneltech
- 515** Radian Robotics
- 411** Raute
- 505** REA JET
- 315** Samuel Coding & Labeling Division
- 598** Samuel Packaging Systems Group – Strapping Division
- 603** SASCO – Polymer Solutions Group
- 601** Shurtape Technologies
- 512** Siempelkamp LP
- 414** Signode Packaging Systems
- 413** SonicAire
- 101** SparTek Industries
- 401** Spraying Systems Co.
- 607** Stela Drying Technology Corp
- 604** Stiles Machinery
- 214** Stratachem Solutions Group LP
- 596** Sweed Machinery, Inc.
- 211** Taihei Machinery Works Ltd.
- 312** TSI
- 204** USNR
- 200** Walker Emulsions
- 404** Wanhua Chemical (America) Co., Ltd.
- 610** Westmill Industries USA Corp.
- 507** Willamette Valley Company
- 605** WPS Industries/Eagle Project Services

= DIAMOND SPONSOR BOOTHS **#** = PLATINUM SPONSOR BOOTHS **#** = GOLD SPONSOR BOOTHS
= SILVER SPONSOR BOOTHS **#** = EXHIBITOR BOOTH LOCATION ***** = NOT EXHIBITING

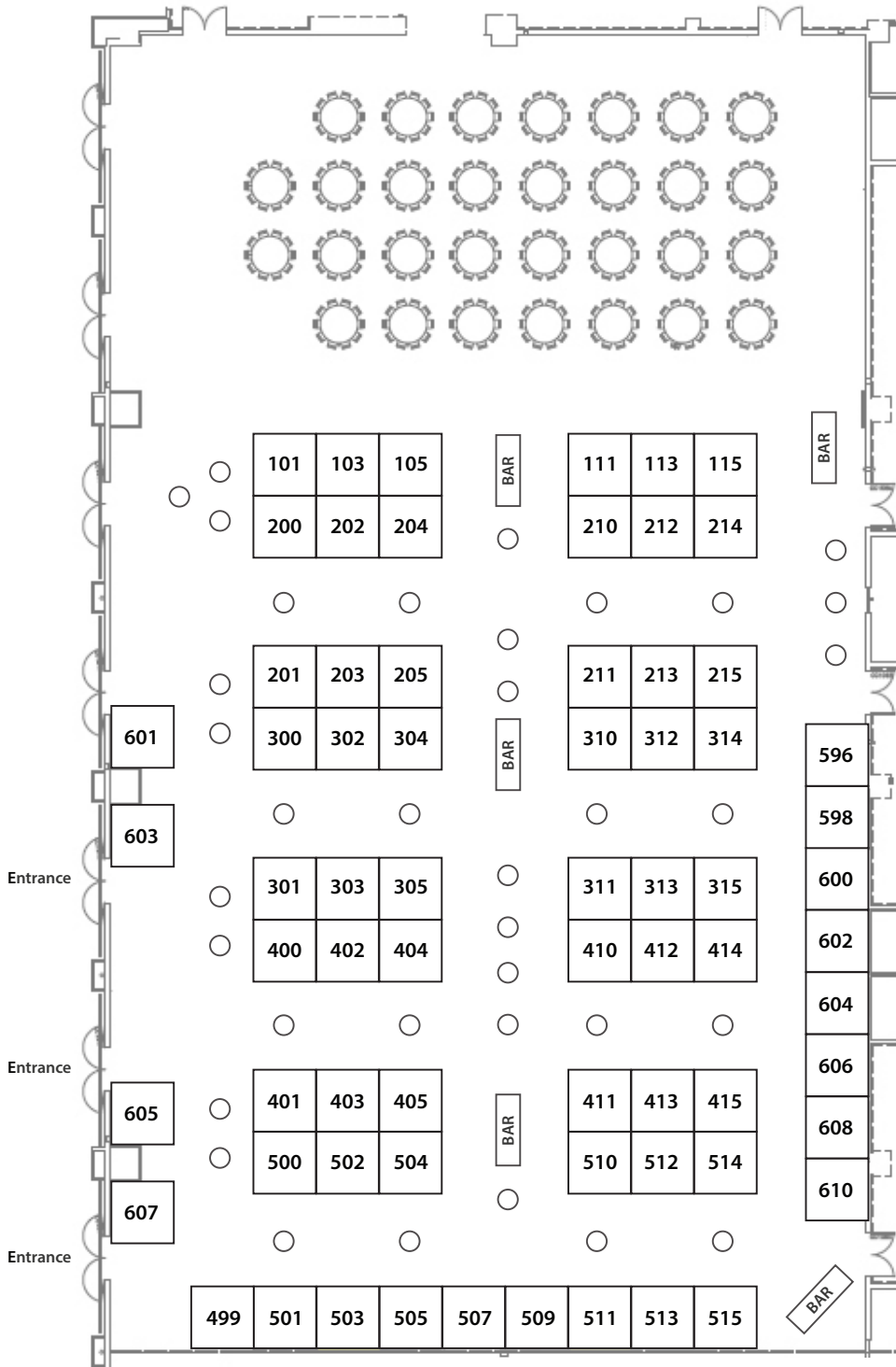

Thank You

MARKET OUTLOOK

More of the Same in 2025?

By Joe K. Elling



In the Spring 2024 *Engineered Wood Journal*, the key message provided little reason to be optimistic about the prospects for 2024. That message is still intact.

Let's look at multifamily starts first.

Through the first half of this year, multifamily starts have averaged a seasonally adjusted annual rate of 343,000, down 35% from the first half of 2023. (See Figure 1.) Although the number of multifamily units under construction at the end of June was down 115,000 from June 2023, there were still 895,000 units under construction. This extraordinarily large number of units under construction is going to be an anchor on multifamily starts through the next 12 months, if not longer.

In contrast, single-family starts through the first half of 2024 were up compared to the first half of 2023. Single-family starts averaged a seasonally adjusted annual rate of 1.04 million units, up 17% from the first half of 2023. As shown though in Figure 2, single-family starts in the second half of 2023 averaged a seasonally adjusted annual rate of 1.02 million. There are several factors in place suggesting that single-family starts could run below the 1 million rate in the second half

of this year, annualized. These include the following:

- Affordability challenge driven by the 6.75% rate on a 30-year fixed-rate mortgage
- Deterioration in home builder sentiment
- Inventory of new homes over nine months supply basis

It appears single-family starts could average 950,000, annualized rate in the second half, leaving starts totaling nearly 1 million units, still up 5% for the year.

Continues on next page.

Figure 1
Multifamily Starts
(Seasonally adjusted annual rate, 1,000s)

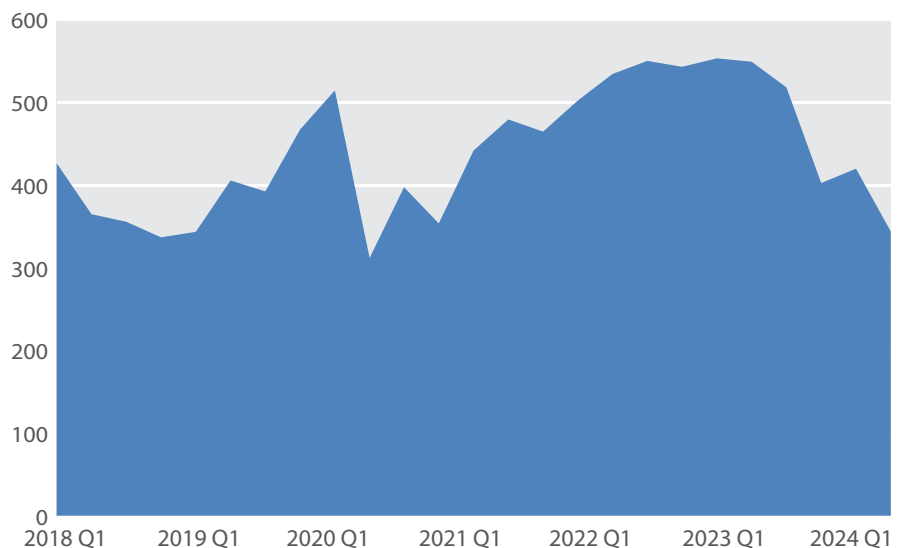

Source: Census Bureau

Too Much Attention on Federal Reserve?

The business media seems obsessed by speculating the week before meetings of the Federal Market Open Committee: “Will policymakers at the Federal Reserve cut the federal funds rate 25 basis points?” Even if the Federal Reserve cuts the federal funds rate by 25 basis points in September and again in December, there is no guarantee that long-term interest rates will follow suit. The Federal Reserve has the means to target the federal funds rate — the overnight rate that banks charge one another. However, this is not true for long-term interest rates, which are set by the interactions of buyers and sellers of long-term financial securities.

Typically, the yield on long-term financial securities, such as 10-year Treasury bonds, exceeds short-term yields because of the risk of longer-term loans. Since the first quarter of 2023, the opposite has been true, driven by the tightening of monetary policy by the Federal Reserve. (See Figure 3.)

One factor that will influence long-term interest rates is the federal government’s borrowing needs to cover its spending excesses relative to tax revenues. As we move toward the November presidential election, the leaders of the major parties are not

Figure 2
Single-family Starts
(Seasonally adjusted annual rate, 1,000s)

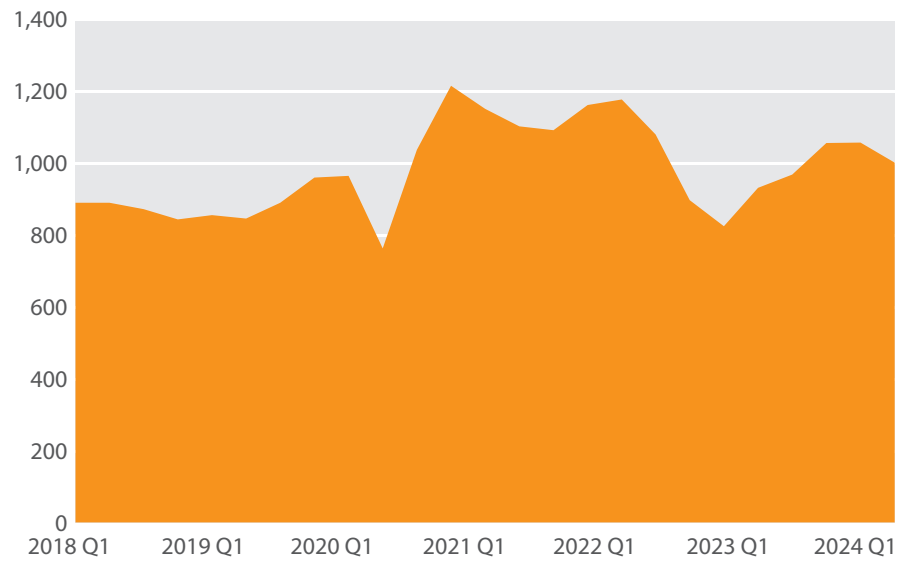

Source: Census Bureau

Figure 3
Interest Rates, U.S.
(Seasonally adjusted annual rate, 1,000s)

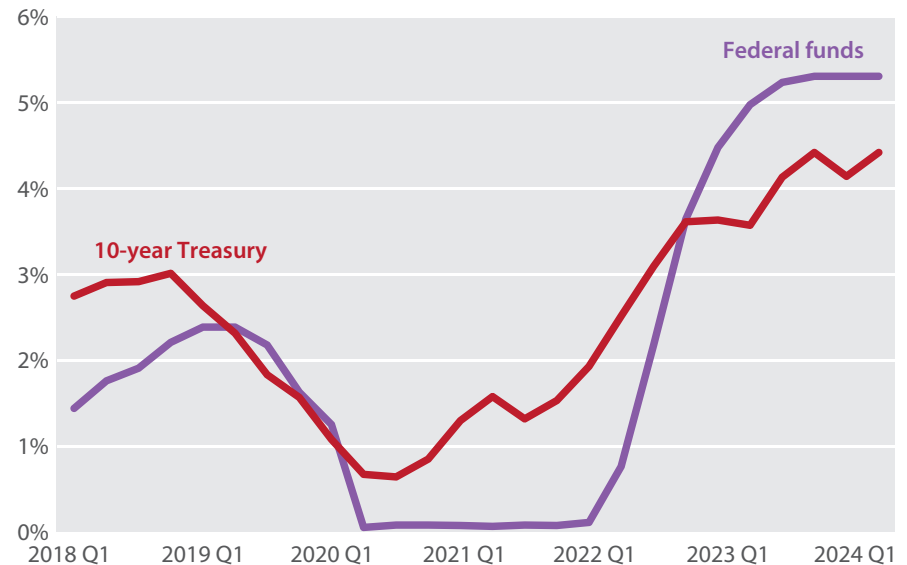

Source: Federal Reserve

talking about fiscal discipline, meaning budget deficits will run in the \$2 trillion range. At the same time, the Federal Reserve will continue to be a net-seller of long-term financial securities as it reduces the bank’s holdings

of U.S. Treasuries and mortgage-backed securities. Since June 2022, Federal Reserve holdings of U.S. Treasuries and mortgage-backed securities have declined by \$1.34 trillion and \$400 billion,

Continues on next page.

respectively. (See Figure 4.) Therefore, we should expect little move, if any, in long-term interest rates, as the Federal Reserve eases at the short end of the market.

Marginal Improvement in Starts in 2025

There is little reason to expect housing starts in 2025 to be much different than in 2024. On the single-family side, a slight change in the average level of mortgage rates in 2025 from 2024 means existing homeowners will remain reluctant to trade up because for many it would entail giving up their 3-4% mortgage. The reluctance to move will be seen in the historically small number of existing homes for sale and contribute to the upward pressure on home prices, which has been the case for the last two years. Therefore, single-family starts are projected at 1.05 million units in 2025, marginally higher than 1.0 million units in 2024.

Multifamily starts are expected to total 350,000 units in 2025, up from 340,000 units this year. It is going to take 12-18 months to absorb the oncoming supply, implying minimal upward pressure on rents in several markets. There will be no relief on financing costs, given the interest rate outlook.

In total, housing starts are projected at 1.40 million units in 2025, up 60,000 units, or 4%,

Figure 4
Federal Reserve Holdings of U.S. Treasury Securities and Mortgage-Backed Securities
(Trillion \$, End of Month)

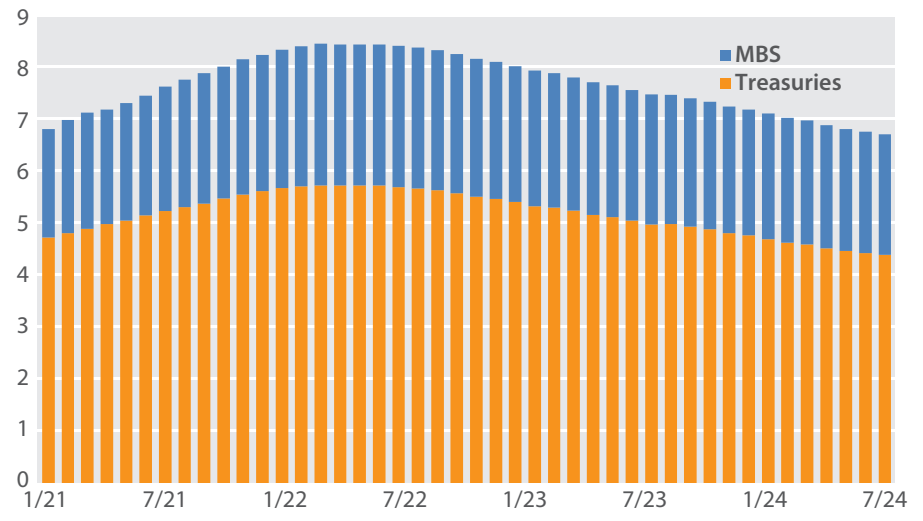

Source: Federal Reserve

from 2024. (See Figure 5.) This level of construction is insufficient to keep up with growth in the number of households, replacement of units destroyed by disaster and demolition of non-economic units. It is clear that there is an insufficient supply

of housing units. Estimates of the shortage range from 2 to 5 million. To make any meaningful dent in the shortage and meet the trend demand for new housing units, starts need to run in the 1.8-2.0 million range for several years.

Continues on next page.

Figure 5
Housing Starts, U.S.
(Millions)

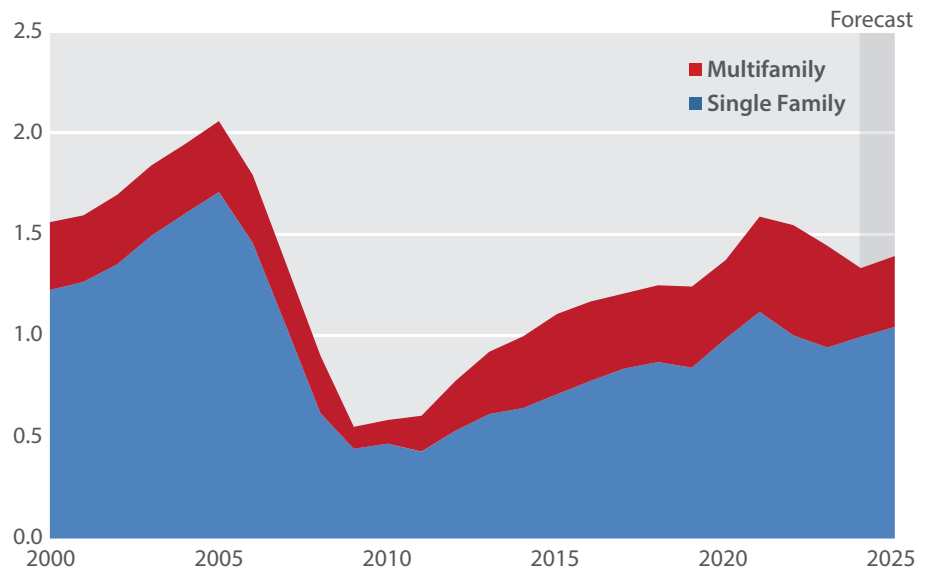

Source: Census Bureau, APA Forecast

Other Factors Affecting Wood Products Use in New Home Construction

Two other factors that will continue to chip away at the use of wood products in new home construction are home size and foundation type. The average size of new homes started in 2023 was 2,409 square feet, down 76 square feet, or 3.1% from 2022. In the first quarter of this year, the average size of single-family homes started was 2,343 square feet. The downward trend in average size since 2015 reflects home builders adjusting their products to partially offset the affordability challenge. Part of that adjustment is the increase in the share of single-family units started that are townhomes or row houses. In 2015, 12.6% of single-family starts were townhomes or row houses. In 2023, the share was 16.7%. As shown in Figure 6, the average size of new homes started is expected to fall in 2024 and again in 2025.

In 2023, the share of homes built with a basement or crawl space was 28.4%. That is only about half of what the share was in 2000. (See Figure 7.) The decline in share has been driven by an increase in the share of homes built in the South and Southwest where concrete on slab is the dominant foundation type. The second driver has been home builders throughout the nation

are building on concrete slab to reduce construction costs. For example, in the Northeast, the share of homes built with a basement or crawl space was 90% and in 2023, that share was down to 75%. In the Midwest, the share of homes built with a basement or crawl space has fallen from 87%

to 61%. This trend has subtracted from the use of structural panels, I-joists and lumber. We do not expect a reversal of this trend in the near term. 

Joe K. Elling is director of market research for APA – The Engineered Wood Association.

Figure 6
Average Size of New Homes Started
(Square Feet)

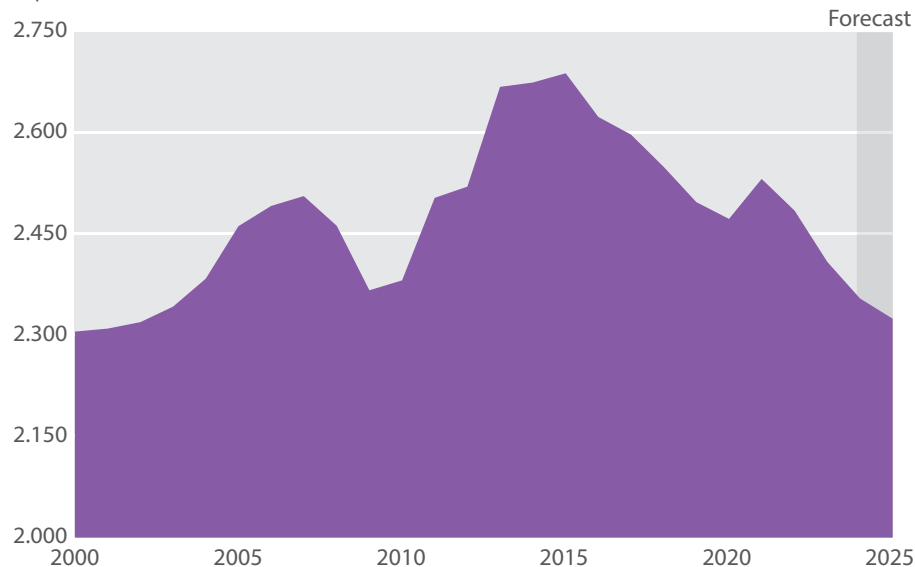

Source: Census Bureau, APA Forecast

Figure 7
Share of Homes Built With Basement or Crawl Space

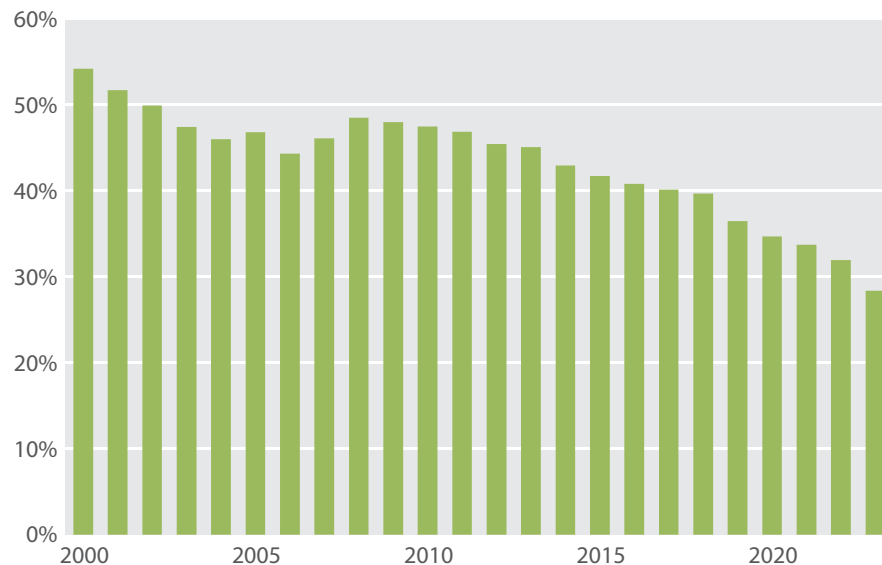

Source: Census Bureau, APA Forecast

Improve Your Mass Timber & Engineered Wood Products with Bostik's ISOSET™ EPI, PEP, and MAX structural urethane adhesives

OFFERING:

- PRG-320 code approval for peace of mind construction and occupant safety
- Faster strength build for increased manufacturing flexibilities
- Ambient application and cure for ease of use and reduced energy usage
- Moisture and solvent resistance for improved product longevity
- Color neutrality for enhanced aesthetics
- Low VOC, solvent and formaldehyde free

Compete with and exceed traditional building materials.

LEARN MORE ABOUT ISOSET™ HERE:



BOSTIK

INFO FAIR
BOOTH
#400



Structural Urethane Adhesives to Enhance Engineered Wood & Mass Timber Products

By Tom Stewart



As mass timber and engineered wood manufacturers know, there are several adhesive technologies that can work for their assembly applications. However, when urethane structural adhesives are used, manufacturers can meet industry standards while also reducing environmental impact and costs overall compared to traditional building materials.

How Urethane Structural Adhesive Systems Help Mass Timber and Engineered Wood Products

MEET INDUSTRY STANDARDS

In the building and construction market, it's required to use materials that meet or exceed building codes to help ensure occupant safety. Because the codes are stringent and ever evolving, especially for fire ratings, it can be challenging to always use products that meet them. Certain urethane structural adhesive systems are certified to pass PRG-320 standards for strength, durability, fire and creep testing. This helps mass timber and engineered wood product manufacturers offer excellent thermal stability to withstand high temperatures, such as those during a fire, and maintain structural integrity.

Also, urethane structural adhesives form strong chemical bonds that enable mass timber and engineered wood products to extend application longevity. Their high strength stems from key formulation elements, such as flexibility, wet out and chemical crosslinking, yielding optimal performance properties. Because urethane structural adhesives possess a high level of flexibility once cured, they're able to absorb and distribute stress loads effectively. This, coupled with the ability to bond substrates with imperfect surfaces, enhances strength and reduces the likelihood of product failure over time. With fast strength build and curing formulations, urethane structural adhesives can also be used for finger joining applications. Finger jointing allows the joining of smaller wood pieces to make larger, usable elements. Further, their resistance to environmental extremes, such as temperature and moisture changes,

helps to maintain bond integrity and prevent swelling, warping and delamination even when exposed to harsh environments.

How Urethane Structural Adhesive Systems Help Mass Timber and Engineered Wood Products

REDUCE ENVIRONMENTAL IMPACT

Mass timber and engineered wood are also more sustainable than traditional building materials. During manufacturing processes, they inherently require less energy-intensive processing, which yields fewer greenhouse gas emissions and pollutants compared to steel and concrete. They also are lighter weight and yield fewer carbon emissions during transit. When manufactured with urethane structural adhesives, the production carbon footprint is further lowered. Urethane structural adhesives possess ambient application and curing properties. In addition to reducing energy consumption and costs associated with heating equipment, this capability helps streamline production efficiencies. Urethane structural adhesives also have low odor and produce low VOCs, which improve worker safety. Further, they offer adhesion across mass timber and engineered wood applications, which helps reduce SKU volume and product waste potential.

How Urethane Structural Adhesive Systems Help Mass Timber and Engineered Wood Products

REDUCE MANUFACTURING COSTS OVERALL

While sustainable materials are often considered expensive due to the additional processing needed to create them, this is not the case when comparing mass timber and engineered wood to traditional building materials. They require less energy to produce, which decreases overall manufacturing costs.

Further, urethane structural adhesives offer excellent processing and coverage rates, which helps minimize adhesive waste and material usage. Additionally,

Continues on next page.



these adhesives have fast curing times. This reduces the need for clamping and can allow for labor to be used more effectively. Their strength and durability can also contribute to decreased maintenance and repair needs in the future.

Urethane structural adhesives also can be custom formulated to maximize productivity and associated costs. For example, their open time can be altered to be specific for a given application, allowing manufacturers to get the quickest reactivity for processing needs.

For more information about how urethane structural adhesives enable mass timber and engineered wood manufacturers to compete against traditional building materials, contact a Bostik adhesives expert.

Tom Stewart, Bostik's Durable Goods - Building Components regional business director, has over 20 years of adhesive industry experience with a focus on structural adhesives and engineered wood products for the



Tom Stewart

building and construction market. Since joining Bostik, the adhesive solutions segment of Arkema, he has used this expertise to drive strategic growth within the engineered wood/mass timber areas, identifying how the company's products can address customers' production and end-use performance goals while reducing the overall environmental impact. Tom is also active in the industry, serving on the APA-EWTA Advisory Committee and advocating for inherently sustainable products. Contact Tom today at tom.stewart@bostik.com to learn more about his efforts and how Bostik's structural adhesives can meet your engineered wood and mass timber product needs. 

ANSI / APA PRG 320

American National Standard for Performance-Rated Cross-Laminated Timber

This standard provides requirements and test methods for qualification and quality assurance for performance-rated cross-laminated timber (CLT), which is manufactured from solid-sawn lumber or structural composite lumber (SCL) intended for use in construction applications. Product performance classes are also specified.

A downloadable PDF is available from the APA – The Engineered Wood Association's Resource Library at www.apawood.org.



COMPLETE GREEN END SOLUTIONS FOR VENEER AND PLYWOOD

REAL WORLD – REAL RESULTS – REAL PROOF

- Customer preferred supplier of mechanical, scanning, and motion control technologies
- Increase production, recovery, quality, and uptime
- Online and in-person service and support
- Continuous innovation and new product development
- ISO 9001 Certified Quality Management Systems

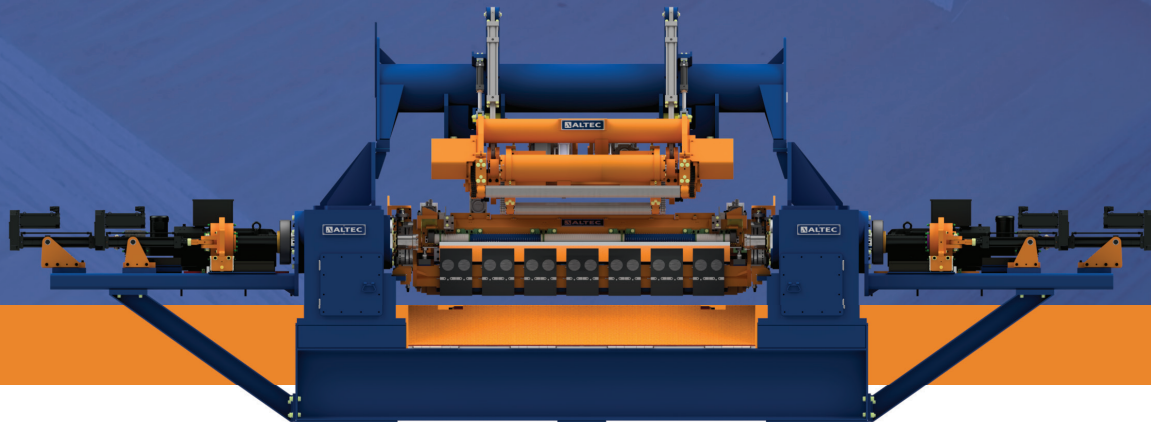

✉ info@alteconline.com

📍 Coquitlam, British Columbia & Diboll, Texas

☎ +1-604-529-1991

INFO FAIR
BOOTH
#310



alteconline.com



MANUFACTURERS RECOGNIZED FOR DEDICATION TO WORKPLACE SAFETY

APA – The Engineered Wood Association has announced the winners of its 2023 Safety and Health Awards — the premier safety award program for North America’s engineered wood products industry. The program promotes and recognizes operational excellence with the goal of reducing injury and illness rates.

Seventy-three APA member engineered wood product facilities participated in the 2023 program. Twenty facilities representing eight APA member companies earned awards in various competition categories. Some mills were multiple award winners. “We take pride in our members’ hard work and dedication to improving worker safety each year,” said APA President Mark Tibbetts. “It’s crucial that as an industry, we advance and adopt best practices to ensure our workplaces remain as safe as possible.”

The Safest Company Award went to two members. Canfor won in the category of three or fewer mills, while West Fraser took the title for companies with four or more mills. There were also two winners in the coveted Innovation in Safety Award category. PotlatchDeltic’s St. Maries, Idaho, mill won the Equipment-Based Innovation Award with its “Automatic Hot Press Panel Feeders.” RoyOMartin’s Alexandria, Louisiana, mill won the Jeff Wagner Process-Based Innovation Award for its “The IBIZ Now Safety Show.”

APA is proud of industry progress to develop and implement systems and processes that continue to decrease incidents and improve worker safety. More information on the APA Safety and Health Awards Program can be found on the Association’s website at www.apawood.org.

Congratulations to the following winners:

EQUIPMENT-BASED INNOVATION IN SAFETY AWARD WINNER

PotlatchDeltic — St. Maries, Idaho
Automatic Hot Press Panel Feeders

PotlatchDeltic's plywood facility in St. Maries, Idaho, was evaluating opportunities to increase safety while remaining focused on providing high-quality results for specialty panel markets. Veneer sheets move through the layup line with applied glue, and pre-pressed pieces are then fed into the vertical hot press one at a time to bond the plywood panels through the use of heat, time and pressure. Panels were historically fed into the hot presses manually by team members hand feeding them one by one into the press. This process created shoulder and hand ergonomic issues, as well as sliver risks. In addition, panels were occasionally damaged as they were pushed into the press resulting in issues like edge delamination.



Team members were tasked with finding a way to automate the process to reduce safety issues and improve quality. The first mill panel feeder was built by Larry Fors, Maintenance Supervisor at the time. Over time, several versions have been made to perfect the idea and enable it to handle the product in ranges from 3/8" to 1.5" panel thicknesses produced in the mill. Approximately 2.8 million panels that were fed manually are now fed automatically into the hot presses each year. The automated feeding system is a pneumatic feeder on a rail system. Air cylinders on rails extend out and use rollers across the top of the panel to adjust the width and then pull the panel into the press platen with an adjustable backstop to avoid feeding double panels. The press panel feeder designs worked so well that an adapted version of the press feeder systems was then installed on three of the core compositors where core veneer is made,

eliminating the need for team members to lockout and manually place bottom boards.

What started as press feeder automation for ergonomic safety has now resulted in multiple solutions for safety and quality with five of these automated panel feeders incorporated into production at the St. Maries plywood mill. Others in the industry have since adapted to the approach on both presses and compositors.

JEFF WAGNER PROCESS-BASED INNOVATION WINNER

RoyOMartin — Alexandria, Louisiana
The IBIZ Now Safety Show

Safety is a serious subject, but that doesn't mean it can't be personal.

RoyOMartin's new corporate safety program, "I Believe in Zero Now"



(aka, IBIZ Now), aims to make safety training personal, engaging and relevant. The company's communications team replaced the existing Occupational Safety and Health Administration (OSHA) PowerPoint training materials with informative and engaging videos.

Working in collaboration with RoyOMartin's safety department, the communications team produced one video every month during 2023. These videos are informative but also fun and inspirational, showcasing the best of RoyOMartin's people and facilities. The team also drafted a branded multiple-choice safety quiz for workers to accompany each video.

The videos were a success. Attention in training sessions and participation on safety committees increased, and employees were enthusiastic to participate in future videos.

Continues on next page.

SAFEST COMPANY AWARD

Three or Fewer Mills
West Fraser

Four or More Mills
LP

ANNUAL SAFETY AND HEALTH AWARD

Division 1 – Plywood
1st Place
Boise Cascade Company
Chapman, Alabama

2nd Place
Boise Cascade Company
Rogue Valley, White City, Oregon

Division II – OSB
1st Place
LP
Hayward, Wisconsin

2nd Place
LP
Clarke County, Thomasville, Alabama

Division III – Glulam, CLT, I-Joist, LVL and SCL
1st Place
Boise Cascade Company
Homedale, Idaho

2nd Place
Resolute Engineered Wood
St. Prime, Quebec

3-YEAR SAFETY AWARD

Division 1 – Plywood
RoyOMartin
Chopin, Louisiana

Division II – OSB
LP
Dawson Creek, British Columbia

Division III – Glulam, CLT, I-Joist, LVL and SCL
Resolute Engineered Wood
St. Prime, Quebec

SAFETY IMPROVEMENT AWARD (2021 - 2023)

Division 1 – Plywood
Roseburg Forest Products Company
Riddle, Oregon
64.69% Improvement

Division II – OSB
LP
Hayward, Wisconsin
100% Improvement

Division III – Glulam, CLT, I-Joist, LVL and SCL
Boise Cascade Company
Thorsby, Alabama
80.69% Improvement

APA SAFETY & HEALTH ADVISORY COMMITTEE MEMBERS

Steve McKenney, Chair
Roseburg Forest Products Company

Cole Bryant, Vice Chair
RoyOMartin

Terry Evans
Boise Cascade Company

Chris Fowler
Canoe Forest Products Limited

Sam Newbill
Hood Industries, Inc.

Dave McGowin
LP

Derek Bauchman
Mercer Mass Timber

Brent Way
Murphy Company

Stanza Donald
PotlatchDeltic Corporation

John Myers (alternate)
Roseburg Forest Products Company

Terry Secrest
RoyOMartin

Natalie Monroe (alternate)
RoyOMartin

Kaitlyn Stacey
Tolko Industries Ltd.

Johnny Sauls
West Fraser Timber Co. Ltd.

Shauna Dunn, CSP
Weyerhaeuser

APA Staff Contact:

Charles Hartke
APA – The Engineered Wood Association



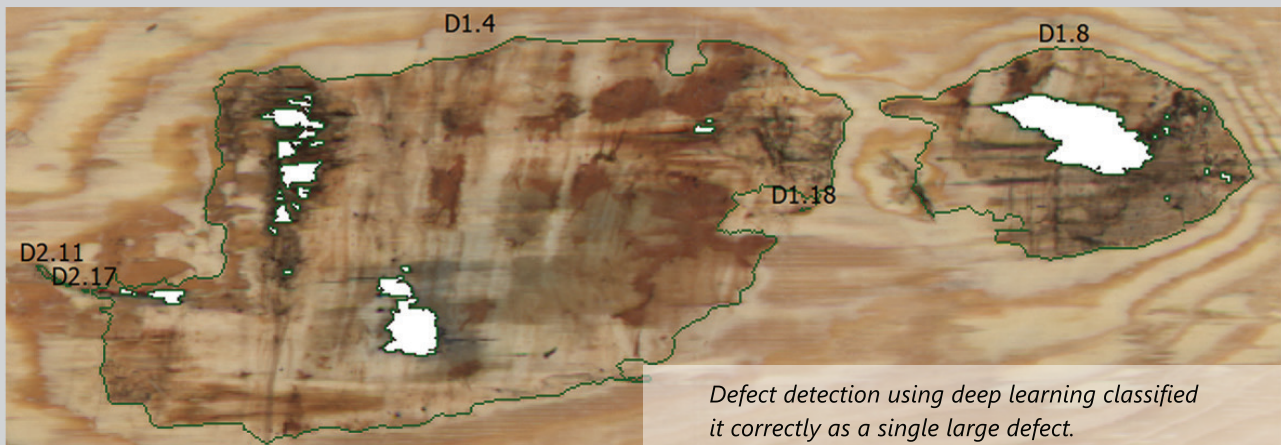
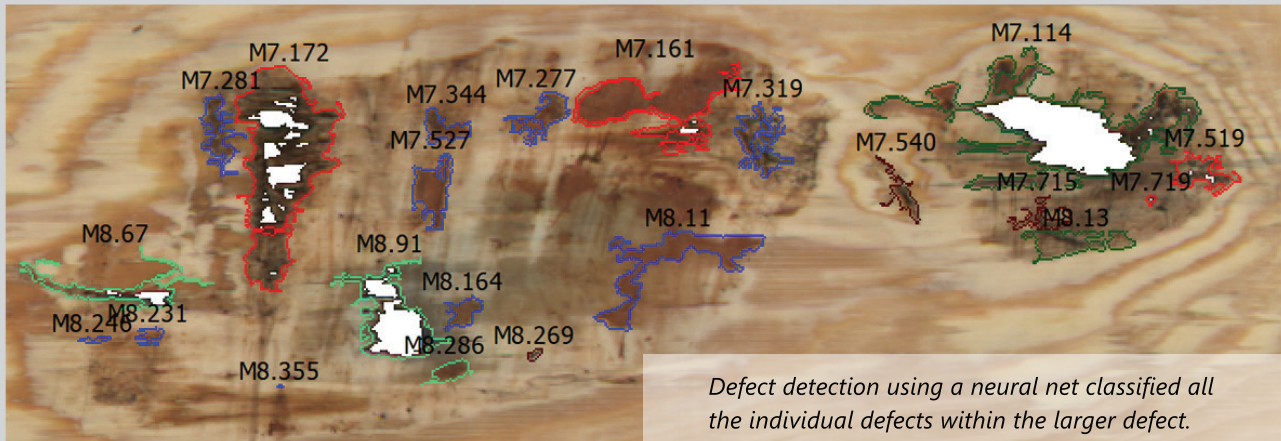

Instant value uplift with deep learning AI

INFO FAIR
BOOTH
#204

USNR has applied its AI-driven deep learning technology, proven in sawmill grade optimizers, to the NV4g green-end and GSc2000 dry-end veneer grading platforms. The result is a paradigm shift in solution accuracy that achieves a new level of defect detection. It makes grading solutions more accurate and more profitable.

Several systems are installed and operating with impressive results. Mills report improved grading accuracy and an increase in higher-grade finished products.

Faster to startup up, more accurate, and easier to use than a traditional neural net classifier, deep learning is available as a new system or an upgrade. *Contact us today to learn more.*

INTENTIONAL CONVERSATIONS

One Habit That Will Transform Your Leadership Skills

By Steve McKenney



I like reading articles and books about becoming a better leader. These resources usually suggest a list of seven or more things to do to improve your leadership skills. I do not know about you, but I cannot remember to do seven things, but I can usually remember to do one thing. Sticking with what has served me well, I suggest there is one thing that can support your desire to become a more effective leader. That one thing is engaging in intentional conversations with the people you support.

Another obstacle for me is committing to doing something every day. My days are so irregular that it

is hard for me to get to everything I want to do every day. What I can do though, is commit to regular conversations that are frequent enough to maintain a connection. The frequency can be based on the team's needs and my awareness of ongoing situations as they reveal themselves during these conversations.

Intentional conversations are a highly effective platform for you as a leader to share crucial information and allow your team members to voice their concerns, ideas, and feedback. This two-way communication is essential for building a healthy team environment.

Continues on next page.

Intentional conversations also are an opportunity to provide a platform for inclusive communication for your team members. Not all team members are comfortable speaking up in group settings. Individual intentional conversations ensure everyone has a voice, fostering a more inclusive and collaborative environment. Routine, intentional conversations help build trust. When team members feel heard and valued, they are more likely to trust you as a leader, which will foster their engagement in the workplace, which will result in improved engagement and productivity.

There are also challenges when it comes to engaging in intentional conversations. It is easy to talk to team members you have a good relationship with. However, intentional conversations with challenging team members may not be as easy or enjoyable. However, over time these difficult conversations can lead to significant breakthroughs in understanding and collaboration. It has been my observation that

having intentional conversations with challenging team members results in the most productive gains.

By investing the time in having intentional conversations, you will demonstrate that you value your team members' input, reinforcing the message that each person's contribution is important. These conversations will help you as a leader to stay aware of your team's evolving needs and allow you to adjust your approach accordingly, ensuring the team remains aligned and motivated.

Intentional conversations are a vital leadership tool for building trust, fostering communication and confirming the value of each team member. These conversations allow you to stay connected, informed, and adaptable to your team's needs. 

Steve McKenney is the Western regional safety manager at Roseburg Forest Products Company and the current Chair of the APA Safety and Health Advisory committee (SHAC).

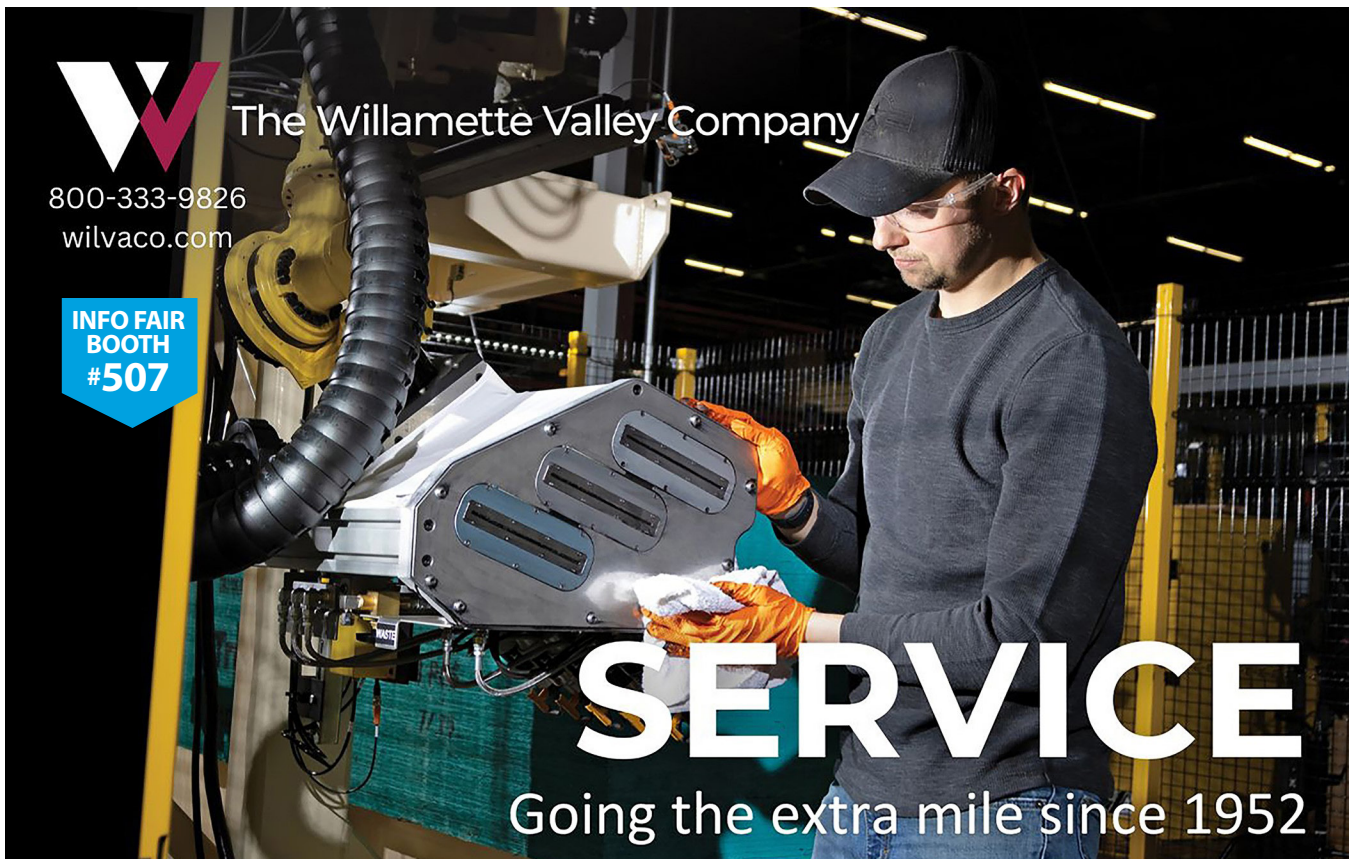

**The Willamette Valley Company**

800-333-9826
wilvaco.com

**INFO FAIR
BOOTH
#507**

SERVICE

Going the extra mile since 1952



2024 SUPPLIER AWARDS

Annual Recognition for 2024 Innovation and Excellence to be Announced September 30

EWTA members are recognized annually for innovative practices and excellence in service by APA members who are invited to select the award winners via an electronic ballot. Votes for the Supplier of the Year Awards are cast based on quality, service and delivery. The Supplier Awards, which include three Supplier of the Year Awards and one Innovation of the Year Award, will be presented on Sept. 30 during the APA Annual Meeting Awards Dinner in San Antonio, Texas.

Following are seven Innovation of the Year entries (in alphabetical order, by company) and a list of the Supplier of the Year candidates sorted by category. Additional information on the entries and awards program is available on EWTA's Supplier Awards webpage at www.engineeredwood.org/awards.

2023 SUPPLIER AWARD WINNERS

Supplier of the Year:

Equipment and Tooling:

IMAL-PAL Group

Materials and Supplies:

The Willamette Valley Company

Consulting and Services:

Panel World Magazine/Hatton-Brown Publishers, Inc.

Innovation of the Year:

**The Willamette Valley Company:
Engineered Wax Emulsion for
Wood Composites**

[VIEW WINNERS ►](#)

Innovation of the Year Entries

The Innovation of the Year Award recognizes a company providing a new technology, product or service that has demonstrably reduced production costs, increased productivity, improved product quality or in some other way provided a bottom-line benefit to APA members.

The information for each entry is as claimed by the applicant. EWTA and APA make no claims as to the veracity of the information, nor do they endorse any entry.

ENTRY A: ARGUS Smart-Connected Technologies
KADANT CARMANAH

ENTRY B: Nicholson MLX (3D printed) Debarking Tips
NICHOLSON MANUFACTURING

ENTRY C: Compact Lay-up Line
RAUTE

ENTRY D: A water-based MDI suspension
SMARTECH MANUFACTURING TECHNOLOGIES

ENTRY E: Green Vener Squeezer Press
SPARTEK INDUSTRIES

ENTRY F: KP-14 Vapor Permeable Barrier Coat
THE SANSIN CORPORATION

ENTRY G: Stainable Patch: A bio-inspired polymeric wood repair solution
THE WILLAMETTE VALLEY COMPANY

INNOVATION OF THE YEAR ENTRY A

ARGUS Smart-Connected Technologies

Entered By: Kadant Carmanah

Date of First Use: May 2023

Benefit 1: Prevents unscheduled downtime at the strander with condition monitoring and analysis in real-time.

Benefit 2: Monitors strand quality, improves throughput and reduces strand deviation in real-time.

Measurable results from case studies:

1. Within the first three months of the first pilot installation, the ARGUS Condition Monitoring & Intelligence (CMI) system prevented eight hours of unscheduled downtime by identifying a failing bearing related to excessive drive belt tension. The mill was able to replace the bearing on a scheduled down day and correct the belt tension to prevent further failures.

2. At our second pilot installation, the ARGUS Fines Measurement System (FMS) was installed at the strander outfeed, green screen discharge and blender infeed. The mill can track strand degradation throughout the entire process and now has the ability to fine-tune resin and wax application to match the fines percentage in real time.

Description: ARGUS Smart-Connected Technologies combines and analyzes data from our proprietary vision systems, an array of condition-monitoring sensors and existing PLC tags to provide OSB producers with data-driven insights about how their strander is operating in real time. Live dashboards and reporting delivers accurate trending for Overall Equipment Effectiveness (OEE), with the ability to benchmark strander performance across multiple operators, shifts and/or lines.

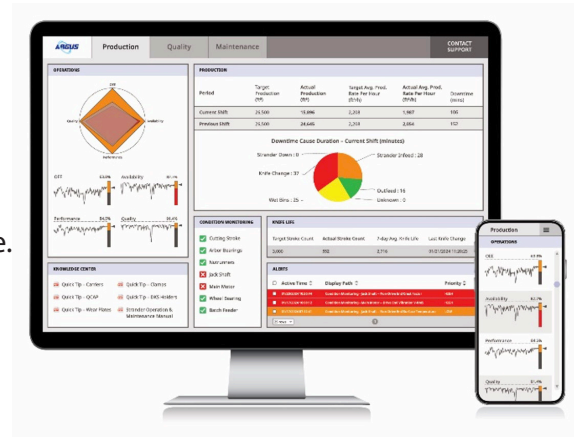

INNOVATION OF THE YEAR ENTRY B

Nicholson MLX (3D printed) Debarking Tips

Entered By: Nicholson Manufacturing

Date of First Use: August 2023

Benefit 1: Increased impact and wear resistance.

Benefit 2: Reduced maintenance and downtime.

Results: Old tips, which would be destroyed in a week or less from rocks, etc., now last 6-11 weeks.

Description: Additive manufactured (3D printed) self-sharpening debarker knife tips replace sintered carbide tips. Nicholson developed a proprietary formula, providing up to 25% increased wear life and up to 10x increased impact resistance. Less maintenance, more uptime, lower cost to run. Results vary depending on the application.



INNOVATION OF THE YEAR ENTRY C

Compact Lay-up Line

Entered By: Raute

Date of First Use: March 2024

Benefit 1: Partial automation benefits without the space and cost of a new automated lay-up line.

Benefit 2: Reduction of labor: The client was continuously burdened with labor shortages. The new line allowed them to reduce spreader labor by six people while maintaining production levels.

Results: In just three months, the customer has realized a 9.4% reduction in labor costs (in the spreader department) with output remaining the same = increase in productivity per man-hour. The customer has already put in another order after three months of results.

Description: The compact lay-up line is approximately 50'x40', while traditional lines are 100'+. This line was developed for those customers who still use roll coaters as opposed to curtain/extruder or spray booth lay-up systems. This is a labor-intensive process, and these mills do not have space for typical automated lay-up lines of 100' or longer. This solution allows mills to take advantage of their existing roller spreader while adding automation to part of the lay-up process.



INNOVATION OF THE YEAR ENTRY D

A water-based MDI suspension for reduced MDI resin consumption in the wood-based panel sector

Entered By: SMARTECH Manufacturing Technologies

Date of First Use: February 2024

Benefit 1: Reducing wood-based panel production costs while increasing panel quality properties.

Benefit 2: Greener product: Lowering the airborne concentration of MDI during production.

Results: 15% reduction in MDI use while maintaining panel performance.

Description: The novel SMARTMDI System delivers a water-based methylene diphenyl diisocyanate (MDI) suspension for the wood-based panel industry. The System generates an oil-in-water suspension of MDI as a substitute for neat MDI, known as the best-performing formaldehyde-free wood binder. The technology overcomes the premature and unwanted reaction between water and MDI with an additive and specific process conditions.

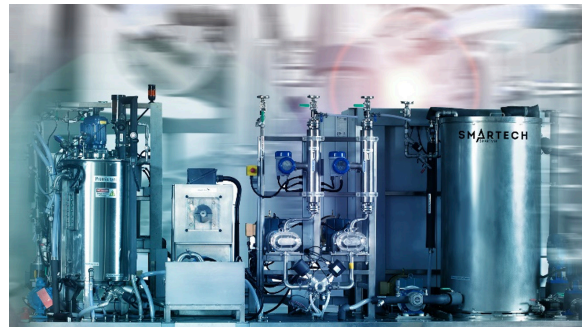

INNOVATION OF THE YEAR ENTRY E

Green Veneer Squeezer Press

Entered By: SparTek Industries

Date of First Use: July 29, 2013 (prototype machine)

Benefit 1: Improves usability of veneer; reduces waste in dry end operations.

Benefit 2: Reduces dryer time; enables increased production capacity.

Results: A 15% (conservative) throughput capacity increase of dry veneer through the dryers.

Description: Uses pressure and position control to migrate water out of saturated pockets located in green veneer and distributes the moisture evenly across each sheet. Average moisture is then a better indicator of moisture content across the full area as opposed to an average to reduce the amount of re-dry wood creating more waste and brittle veneer. By reducing water pockets, the overall moisture content of a veneer sheet can be increased while not increasing re-dry, resulting in a higher quality product.



INNOVATION OF THE YEAR ENTRY F

KP-14 Vapor Permeable Barrier Coat

Entered By: The Sansin Corporation

Date of First Use: May 2024

Benefit 1: KP-14 is a vapor-permeable barrier coating that acts as a barrier to hold water out similar to a traditional rubber membrane. KP-14 is a low-VOC, water-borne, environmentally friendly coating that is more sustainable and more affordable than traditional rubber membranes.

Benefit 2: KP-14 allows for water vapor to escape the wood, helping prevent mold and wood rot.

Results: KP-14 reduces water absorption by 85%. The KP-14 system has a vapor desorption efficiency of 90% comparable to the 92% efficiency of bare wood conforming to EN927-5 and EN927-4 moisture absorption testing standards.

Description: KP-14 is a water-borne vapor permeable barrier coating for engineered wood components like CLT that is designed to aggressively reduce moisture absorption and weathering in the construction phase. KP-14 is ultra-low in VOCs and can be seen as a more sustainable barrier coating to the traditional rubber membranes used. To achieve best results, KP-14 should be used in conjunction with KP-12W. KP-14 can be factory or field applied.

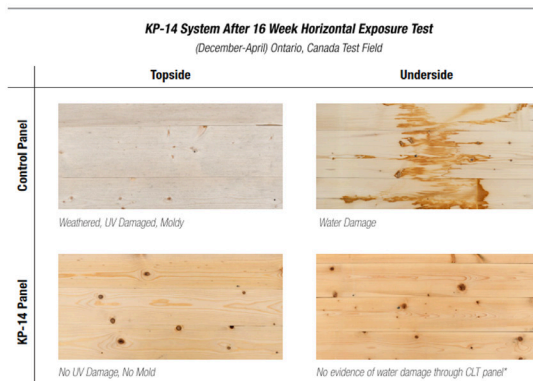

INNOVATION OF THE YEAR ENTRY G

Stainable Patch: A bio-inspired polymeric wood repair solution

Entered By: The Willamette Valley Company

Date of First Use: August 2023

Benefit 1: Enhanced stainability and weathering that is similar to wood substrate minimizing color differential between patch and substrate.

Benefit 2: High biobased content, between 10 and 70%, depending on the application, without compromising performance and stability.

Results: ≥10% reduction in pMDI while maintaining panel performance; about 50°F reduction in wax volatility

Description: Application on plywood, LVL and CLT showed smooth application, excellent stainability and weathering performances. The Stainable Patch tracked the surrounding wood color 97% better than the traditional poly patch. The product passed all the APA tests to meet the highest quality standard.



Supplier of the Year Award Candidates

Each fall, APA members are asked to choose Supplier of the Year winners in three categories (Consulting/Services, Equipment/Tooling and Materials/Supplies) based on quality, service and delivery. Below is a list of candidates, which includes all EWTA members.

To recognize the outstanding service of so many members, the EWTA Advisory Committee implemented a new rule in 2019 that no member is eligible to win two consecutive years.

The 2023 Supplier of the Year winners are noted below.

Consulting and Services (10)

BMI Contractors, Inc.
CMA engineering Inc.
Evergreen Engineering, Inc.
Hansen-Rice, Inc.
Hunt, Guillot & Associates LLC
KTC Industrial Engineering Ltd.
Mid-South Engineering
Panel World Magazine / Hatton-Brown Publishers, Inc.*
Union Pacific Railroad
University of Tennessee, Center for Renewable Carbon

Equipment and Tooling (68)

A-Lert Construction Services
Altec Integrated Solutions Ltd.
Argos Solutions LLC
Baumer Inspection GmbH
BETE Fog Nozzle, Inc.
BID Group
Biele USA LLC
Biomass Engineering & Equipment – Veneer Services, LLC
Brunette Machinery Company Inc.
CECO Environmental: Adwest Technologies, Fisher-Klosterman, HEE-Duall
Clarke's Industries, Inc.
Coil Manufacturing, Ltd.
Combilift
Connexus Industries Inc.
Con-Vey
COSTA Sanders LLC
Dieffenbacher Customer Support, LLC
DO2 Industriel
Dürr Systems, Inc.
Electronic Wood Systems, N.A.
Elite Automation
Fagus GreCon, Inc.
Flamex, Inc.
FROMM Packaging Systems
Globe Machine Manufacturing Company
Grenzebach Corporation
Guardian Chemicals Inc.
HASHIMOTO DENKI Co., Ltd
HAWE Hydraulik
HexArmor
Hexion Inc.
IBC, International Bar Coding Systems & Consulting Inc.
IMA Schelling Group
IMAL-PAL Group*
IMEAS Inc.
Itipack Systems (A & H Custom Machine)
Kadant Carmanah Design
Kimwood Machinery, Inc.
Knight Material Technologies
LIMAB North America
LDX Solutions (Dustex \ Lundberg)
LEDINEK
Matthews Marking Systems
Meinan Machinery Works, Inc.

Mereen-Johnson LLC
Mill Machinery LLC
MINDA North America, LLC
NESTEC, Inc.
Nextwire
Nicholson Manufacturing Ltd.
Radian Robotics
Raute
REA JET
Samuel Packaging Systems Group
Siempelkamp LP
Signode Packaging Systems
SMARTECH (TIP)
SonicAire
SparTek Industries
Spraying Systems Co.
Stela Drying Technology Corp.
Stiles Machinery, Inc.
Sweed Machinery, Inc.
Taihei Machinery Works Ltd.
TSI (Teal Sales Inc.)
USNR
Venango Machine Company, Inc.
Westmill Industries USA Corp.

Materials and Supplies (29)

ACMOS, Inc.
Albany International
Arclin - Performance Applied
Arxada
ATCO Wood Products Ltd.

Axalta Coating Systems
Bakelite Synthetics
BASF - We create chemistry
Bates and Company, Inc
Bostik
Chem-Trend LP
Clarke Veneers and Plywood
Dominion Chemical Company, Inc.
Evertree North America Inc.
Franklin Adhesives & Polymers
Fusoni
Henkel
Huntsman Polyurethanes
Intertape Polymer Group
IPCO
Münzing
Northwest Adhesives, Inc
OCI Melamine Americas
Paneltech
SASCO - Polymer Solutions Group, LLC
Siemer Milling
Stratachem Solutions Group LP
The Sansin Corporation
The Willamette Valley Company*
Walker Emulsions
Wanhua Chemical (America) Co., Ltd.

***2023 Supplier of the Year Award Winners**

MEMBERSHIP DIRECTORY



The Engineered Wood Technology Association (EWTA)

As a related nonprofit supplier organization of APA – The Engineered Wood Association, serves as a networking and information facilitator between North America’s engineered wood product manufacturers and their product, equipment and service providers.

EWTA membership falls under four categories:

- Consulting and Services
- Equipment and Tooling
- Materials and Supplies
- APA Member Manufactures (all members of APA are automatically members of EWTA)

The following directory provides a list of 2024 EWTA members organized by category and includes company descriptions and contact information. Visit www.engineeredwood.org/member-directory-contacts for the online directory and additional filter options. It’s just one of many tools designed to help members connect with each other and the industry.

For more information about the benefits of membership or for a membership application, visit www.engineeredwood.org/-about or contact LaDauna Wilson at ladauna.wilson@apawood.org.



2024 INFO FAIR SPONSORS

Use these designations icons to find the members who are sponsoring in this year's APA Annual Meeting & EWTA Info Fair. See you there!





CONSULTING AND SERVICES

EWTA members in the Consulting and Services category provide support in one or more of the following subcategories: Energy Management; Engineering Services; Industrial Construction and Installation; Industry Communication/Research; Maintenance/Inspection; On-Time Performance Systems; Plant Design and Construction; Project Management; Recruiting and Staffing; Software/Computing/IT; Specialty Services; Value-Added Services/ Treating/Embossing. Go to the online Consulting and Services directory

AFRY Management Consulting

AFRY Management Consulting Wood Products team has a long-standing experience in wood-based panels, engineered wood products, lumber and surfacing materials with an in-depth industry network supported by a global presence and local knowledge. Our service areas include Strategy Advisory, Market Analysis and Forecasting, Investment Advisory, Due Diligences, Valuations and Operational Excellence. Wood Products is part of the Bioindustry Management Consulting Division which includes Forestry and Biomass, Paper, Packaging, Hygiene and Biorefining. AFRY was launched in 2019 when ÅF and Pöyry merged. We are 19,000 devoted experts creating an impact for generations to come. AFRY is listed on Nasdaq Stockholm and a turnover of USD 2.5 billion.

Contact:

Guillermo Velarde - Principle

Phone: 646-715-3928

Email: guillermo.velarde@afry.com

295 Madison Ave., Suite 300, New York, NY 10017

www.afry.com

PLATINUM BMI Contractors, Inc.

BMI Contractors Inc, is a machinery installation contractor specializing in the wood products industry for nearly 40 years. We operate across North America and have installed complete plywood, OSB, LVL and I-Joist facilities. We have replaced, rebuilt or modernized individual machinery lines including over 100 veneer dryers and a significant number of plywood presses, LVL presses and OSB presses. We pride ourselves in innovation and are responsible for completing three veneer dryers that were rolled into place after their construction. Our crews are ready to assist you in achieving your goals for timely, efficient, safe and cost-effective plant improvement projects.

Contact:

David Brown - President

Phone: 503-375-2222

Email: dbrown@bmiccontractors.com

4375 Turner Rd. SE, Salem, OR 97317

www.bmiccontractors.com

CMA engineering Inc.

Since 1986, CMA engineering Inc. has accomplished a number of projects in the manufacturing end of the forest products industry, including the conceptual design, budget preparation, process engineering, detail engineering (mechanical, electrical, civil and structural), equipment procurement, project management, construction management, PLC/HMI programming and start-up of board plants (OSB, particleboard and MDF), plywood and veneer mills, bioenergy plants, engineered wood product plants and sawmills.

Contact:

Claude Malette - P. Eng.

Phone: 705-360-5525

Email: cma@cmaeng.com

60 Wilson Avenue, Suite 101

Timmins, ON P4N 2S7 Canada

www.cmaeng.com

Evergreen Engineering, Inc.

Evergreen is a multi-discipline (mechanical, electrical, civil/structural and environmental) engineering firm. From project planning and feasibility studies through detailed engineering, construction management, maintenance and process consulting, to start-up and commissioning support, Evergreen can handle any project in your mill. Our wood products experience includes OSB, LVL, I-Joist, Particleboard, MDF, Hardboard, WPC, Pulp & Paper, Lumber, Plywood, Chemical and Resin plants. "Our mission is to provide customized support to move our client's vision to reality by delivering practical engineering solutions, displaying project leadership and contributing technical expertise."

Contact:

Aaron Edwards - Director, Industrial Business Development

Phone: 541-484-4771

Email: aedwards@eeeug.com

Eugene Office:

1740 Willow Creek Circle

Eugene, OR 97402-9152

Atlanta Office:

8607 Roberts Drive, Suite 100

Atlanta, GA 30350-2237

www.evergreenengineering.com

GOLD

Hansen-Rice, Inc.

Start with the end in mind. Hansen-Rice, Inc. (HRI) has been providing high-performance design and construction solutions since 1983. Over our 40-year history we've minimized risk and maximized ROI on minor and major capital projects. HRI's Engineered Wood experts leverage extensive plant operations, process engineering, project planning, and fast-track construction experience ensuring your project's success. HRI has the experience, tools, and systems to get your plant planned, designed, and built. We focus on integrating your site, equipment, process, and building to optimize efficiency. We'd love to share how, just start by giving us a call.

Contact:

Matt Brown, Vice President, Industrial Programs

Phone: 208-890-1195

Email: mbrown@hansen-rice.com

1717 E. Chisholm Drive, Nampa, ID 83687

www.hansen-rice.com

Hunt, Guillot & Associates LLC

Hunt, Guillot & Associates, LLC (HGA) is a multi-disciplined project management and engineering design firm. HGA has been serving the forest products industry since the firm's founding in 1997. HGA continues to provide expertise to the Engineered Wood Products, LVL, I-Joist, OSB, Plywood, Particleboard, Glulam and Lumber industries. Services provided include project management, feasibility studies, preliminary engineering, detailed design engineering and on-site technical support services.

Contact:

Kyle Galligan – Lead Project Manager

Phone: 318-269-5497; Cell: 318-243-1773

Email: kgalligan@hga-llc.com

603 Reynolds Drive (PO Box 580), Ruston, LA 71270

www.hga-llc.com

KTC Industrial Engineering Ltd.

"Great projects start here." Expertise, experience, and proven track record second to none. Our staff has designed 24 greenfield plants and completed over 600 projects in the engineered wood industry over the past 30 years. KTC utilizes proven methodology to design machinery and processes while supporting the project management team with accurate budgets and schedules. We are now taking the risks out of projects with Dynamic Process Modeling and Advanced Project Tracking technology.

Contact:

Jan Karnik - President

Phone: 604-592-3123 Ext. 305

Email: jan.karnik@ktceng.ca

#218-12877 76th Avenue, Surrey, BC V3W 1E6 Canada

www.panelboard.net



MID-SOUTH

Mid-South Engineering

Mid-South Engineering is a full service, consulting engineering firm that provides a broad range of professional engineering services. Our multi-disciplined staff has served industrial as well as government and commercial clients with a particular expertise within the forest products industry. Mid-South has offices in Hot Springs, Arkansas; Cary, North Carolina; and Orono, Maine. Established in 1969, MSECO has since grown steadily in knowledge and experience. Our services include Engineering, Project Development, Project Management, and Construction Services. We welcome projects from small troubleshooting efforts to large greenfield plant installations, as Owner's Engineer or as part of a turn-key project.

Contact:

Scott Stamey – Vice President

Phone: 919-481-1084

Email: sstamey@mseco.com

200 Mackenan Drive, Cary, NC 27511

www.mseco.com

SILVER

Panel World Magazine / Hatton-Brown Publishers, Inc.

Panel World publishes six issues per year for domestic and international readership with emphasis on mill project startup articles. Product coverage includes structural and non-structural wood products. Panel World also hosts the biennial Panel & Engineered Lumber International Conference & Expo (PELICE).

Contact:

Rich Donnell - Editor

Phone: 334-834-1170

Email: rich@hattonbrown.com

225 Hanrick Street (PO Box 2268)

Montgomery, AL 36104

www.panelworldmag.com

Union Pacific Railroad

Union Pacific Railroad delivers the goods families and businesses use every day with safe, reliable and efficient service. Operating in 23 western states, the company connects its customers and communities to the global economy. Trains are the most environmentally responsible way to move freight, helping Union Pacific protect future generations. More information about Union Pacific is available at www.up.com.

Contact:

Cori Bumgardner - Manager, Marketing | Industrial

Phone: 402-544-4984; 402-671-4651

Email: cabumgar@up.com

Carey Wilcox - Manager, Marketing | Industrial

Phone: 402-544-4635; 402-212-2271

Email: cawilcox@up.com

1400 Douglas St. Stop 1210, Omaha, NE 68179

www.up.com

University of Tennessee, Center for Renewable Carbon

The University of Tennessee School of Natural Resources (UT SNR) was established in January 2023. Within the UT SNR the 'Data Science Institute for Machine Learning and AI' was established in January 2024 to advance education and research in data science for industries that grow, manage, harvest, and utilize wood and fiber resources. Focus areas will be in data analytics, machine learning, and AI, and provide: training and workshops; graduate and undergraduate student education; and applied research. Member companies will interact with UT SNR faculty, staff, and students. The Institute will function as an expansion of a company's innovation group by providing access to the most current technologies in the rapidly evolving field of data science, machine learning, and AI. A 'Machine Learning (ML) Cooperative' (ML Coop) exists within the Institute to advance the direct application of the most contemporary ML algorithms for real-time prediction of key process parameters and product quality attributes. The academic curriculum will be structured to support the MS Forest Business program within the UT SNR. The MS Forest Business program is open to students at UT and industry will consist of a mostly virtual curriculum. For more information visit, www.agdatascience.tennessee.edu.

Contact:

Donald Hodges, PhD, CF – James R. Cox
Professor and Director

Phone: 865-974-2706

Email: dhodges2@utk.edu

427 Plant Biotechnology Building,

Knoxville, TN 37996-4563

www.agdatascience.tennessee.edu

Go to the online Consulting and Services directory for additional details.

EQUIPMENT AND TOOLING

EWTA members in the Equipment and Tooling category provide products and support in one or more of the following subcategories: Accessory Tools/Equipment; Controls/Electronics/Optimization/Automation; Custom Equipment/Tooling; Dryer Systems; Environmental; Fastening/Fasteners/Hardware; Finishing Line Systems; Grading/Scanning; Hydraulics/Hydraulic Systems; Labeling/Marking/Bar Coding; LVL, Laminate & Other EWP Equipment; Material Handling Equipment; Panel Handling Equipment; Panel Production Equipment; Panel Repair/Patching; Presses and Press Lines; Primary Processing Equipment; Quality Control Equipment and Systems; Resin Application Equipment/Spray Lines; Safety Equipment and Supplies; Sanding and Finishing Equipment; Strandere/Debarkere/Logging; Support Equipment; Veneer Processing and Drying; Wax/Material Application Systems; Wrapping, Strapping and Packaging. Go to the online Equipment and Tooling directory.

PLATINUM Altec Integrated Solutions

Altec works closely with plywood and veneer operations to improve all sections of the green end to increase production, quality, uptime, and recovery. After gaining a thorough understanding of each customer application, an improvement solution, drawn from decades of experience and smart use of technology, is proposed. Improvement solutions are provided which include items such as heavy-duty precision equipment (including complete lathes, back up rolls, chargers, scanners, diverters, stackers, robotics) and enhanced control systems for all sections. Services include full CNC machine shop, testing, engineering, and field service. Locations in Texas and British Columbia allow Altec to supply, service, and support customers across North America and around the world.

Contact:

Bill Long – President

Phone: 604-313-1602

Email: blong@alteconline.com

120 - 185 Golden Drive

Coquitlam, BC V3K 6T1 Canada

www.alteconline.com

PLATINUM Argos Solutions LLC

Argos offers a full range of optical inspection and process control systems that replaces manual grading and patching of wood products. With more than 25 years of experience and installations in more than 30 countries, Argos provides the latest technology of vision-based scanning systems for the plywood, composite and furniture industry. Argos is a single source supplier for inspection and grading after the press, sander, cut-to-size, including edge inspection systems, and automatic patching systems for plywood and parquet panels.

Contact:

Richard Lepine - General Manager

Phone: 919-428-1262

Email: richard.lepine@argossolutions.no

2013 Castleburg Drive, Apex, NC 27523

www.argossolutions.no

Baumer Inspection GmbH

Baumer Inspection GmbH specializes in optical surface inspection systems. In over 35 years of quality service, we have installed more than 750 systems world-wide and are a leader in scanners for fully automatic inspection and process control. Baumer Inspection offers inspection systems for particle boards, wood fiber boards (MDF, HDF), paper, film and foils, flooring and surfaces of furniture panels as well as edge inspection systems. Our highly skilled and motivated team always pushes the limit of what is possible to bring you the newest innovation in vision technology for the wood working industry.

Contact:

Stefan Eisenkohl - Head of Sales & Engineering

Phone: +49 7531 9943-31

Email: seisenkohl@baumer.com

Lohnerhofstrasse 6, Konstanz, 78467, Germany

www.baumerinspection.com

BETE Fog Nozzle, Inc.

Discover solution confidence with BETE's FlexFlow® precision spray control systems for applications of resin, wax, water, and release agents during engineered wood production. Address problems involving overspray or under-spray to ensure production efficiency for chips, mats, cauls, or belts. Our spray technology can help optimize line product zone cooling and applications of mold release, lubricants, fire retardants, adhesives, sealants, or dyes for marking and ID.

Contact:

Melanie Bete – Regional Sales Manager

Phone: 413-834-3315

Email: mmbete@bete.com

50 Greenfield St., Greenfield, MA 01301

www.bete.com

BID Group

The privately-owned BID Group has over 35 years of experience in providing industry-leading solutions for its highly valued customers in the wood processing industry. As one of the largest integrated suppliers to the wood processing industry and the North American leader in the field, BID Group is your one-stop source for comprehensive and innovative solutions that exceed our customer expectations. The ability to provide complete, smart connected, turnkey manufacturing facilities that includes engineering, project management, installation, startup, and after sales service furthers the BID Group companies' strategic value to its customers.

Contact:

Anne-Marie Levesque – Vice President, Business & Product Development

Phone: 450-435-2121

Email: anne-marie.levesque@bidgroup.ca

5154 Highway 78, St. George, SC 29477

www.bidgroup.ca

Biele Group

Since 1973 Biele Group is a global manufacturer of customized equipment and turnkey solutions for plywood, particle board, OSB and solid wood applications. The solutions developed by Biele include veneer handling up to the final packaging lines, going through automatic lay-up systems, press lines and finishing processes, including fully automatic solutions for Hardwood Veneer Press lines. Biele's expertise includes advanced data management and complete plant development from concept and design to installation and commissioning. Headquartered in Spain with local sales & technical support facilities in Atlanta, Georgia, USA, Biele provides full service for projects developed in America.

Contact:

Paul Gavin - Sales Area Manager

Phone: +34-619-21-9-22

Email: biele@biele.com

US Sales Contact:

Juan Flores

Phone: 706-537-2336

Biele USA LLC, 2030 Powers Ferry Road, Suite 228,
Atlanta, GA 30339

www.biele.com

Biomass Engineering & Equipment

We build profitable machine solutions based upon better engineering. We take pride in the fact that our machines run reliably with minimum operating costs - yielding you the greatest efficiency and profits. Every prototype machine ever built is running today. We were the first and still the only company to build a voice activated veneer bundle grading line. We developed the most accurate debarker/planer system ever built and then we built a fully automated butt flare reducer to go with it. Our veneer chipper is proven to use less energy and produce better chips. Our veneer machine rebuilds have allowed our customers to improve profits while saving them as much as 50% over the price of a new machine.

Contact:

Dane Floyd - President and CEO

Phone: 317-346-0711

Email: info@biomass-equipment.com

5851 S. Harding Street, Indianapolis, IN 46217

www.biomass-equipment.com

PLATINUM

Brunette Machinery Company Inc.

Specializing in wood processing machinery and material handling systems for the Forestry and Biomass industries: CBI Grizzly Mill, BioSizer®, Chippers for Pulp-chips or Micro-Chips, Electric Log Sweeps, Log Decks, Log Singulators, Rotary Debarkers, Vibrating Conveyors. Custom engineered solutions to take control of your fiber supply and get more from your mill.

Contact:

Kristy Hammond

Phone: 604-522-3977

Email: kristy@brunettemc.com

8717 132nd St., Unit 21 - 4444 Eastgate Parkway, Surrey, BC V3W 4P1, Canada

www.brunettemc.com

CECO Environmental: Adwest Technologies, Fisher-Klosterman, HEE-Duall

Adwest Technologies provides high efficiency Regenerative Thermal and Catalytic Oxidizers (RTOs and RCOs) for engineered wood, OSB, MDF, laminating, veneer drying, and resin VOC abatement. Adwest can provide compact 2 chamber RETOX RTOs as well as multi chamber RTOs up to 400,000 SCFM flow rates. Our Fisher-Klosterman, Inc (FKI) division provides ultra-high efficiency cyclones and venturi scrubbers for boiler and wood manufacturing applications, while HEE-Duall provides Bioreaction biofilter and scrubber systems for VOC abatement. We also service, rebuild and relocate RTOs, RCOs, Biofilters and scrubbers for the wood products markets including Smith, Pro-Environmental and all other brands.

Contact:

Jeff Yerkes - Key Account Manager, Adwest

Phone: 714-632-9801

Email: jyerkes@onececo.com

680 Langsdorf Drive, Fullerton, CA 92831

www.cecoenviro.com

Clarke's Industries, Inc.

Clarke's provides a broad range of products for the Panel Board Industry. The products include Material Storage and Metering Bins, PyroGuard Spark Detection and Extinguishment System, Hi Speed Abort Gates, Back draft Dampers and Explosion Venting, Waste Wood Processors, Rotary Screens and Classifiers, Rotary Airlocks/Feeders, Fans, Dust Collection and Pneumatic Conveying Systems.

Contact:

Andy Clarke - President

Phone: 541-343-3395

Email: andyc@clarkes-ind.com

660 Conger Street (PO Box 2428), Eugene, OR 97402

www.clarkes-ind.com

GOLD

Coil Manufacturing Ltd.

Coil Manufacturing offers robust solutions for resin application with our advanced Coil Blenders and high-speed spinning disc atomizers. Our Coil Blenders, made from durable rolled steel and advanced linings, come in capacities ranging from 4,000 to 80,000 pounds per hour and sizes from 7' to 13' in diameter and 8' to 45' in length. These versatile blenders efficiently handle both liquid and powder resins. In addition, our spinning disc atomizers, available in various models with speeds up to 15,000 RPM, optimize resin consumption. Designed for precision and reliability, they minimize maintenance and downtime, enhancing overall cost-efficiency. Coil Manufacturing's high-quality blenders and atomizers ensure precise, reliable, and cost-effective resin application processes.

Contact:

Mike Coil - President & CEO

Phone: 604-596-7578

Emails: mdc57@telus.net or
mike@coilmanufacturing.com

8269 - 130th Street, Surrey, B.C., V3W 7X4 Canada

www.coilmanufacturing.com

Combilift USA

Combilift is the largest global manufacturer of multi-directional forklifts and an acknowledged leader in long load handling solutions. Innovation, Flexibility and Service is the ethos on which Combilift's success is built and has seen us become the world's fastest-growing forklift manufacturer, exporting to more than 85 countries and with more than 60,000 trucks in use worldwide. No other manufacturer in the world can deliver the same level of customisation and adaptability, or cater so effectively to the diverse needs of every individual customer, whether their enterprise is large or small.

Contact:

Daniel Soden - Marketing

Phone: 877-266-2456

Email: daniel.soden@combilift.com

303 Concord St., Greensboro, NC 27406

www.combilift.com

Connexus Industries Inc.

Connexus Industries Inc. manufactures and distributes specialized chain, attachments and sprockets for OSB manufacturing plants. We also are manufacturers of Laharco Laser Diodes and Rens-Metal Shark Metal Detectors. Locations in Atlanta, Quebec, Portland and Vancouver. Formerly Viking Chains, I'ANCO Products and Lacey Harmer Inc.

Contact:

Rudi (Mr.) Pieterse – President & CEO

Phone: 604-882-1602

Email: rpieterse@cnxsind.com

27474 Gloucester Way, Langley,
BC V4W4A1 Canada

www.connexusindustries.com

**CON-VEY**

SILVER

Con-Vey

Con-Vey is a comprehensive industrial automation provider based in Roseburg, OR. We engineer and manufacture complete systems and custom integrated solutions for wood products, focusing on finishing lines and value add processes. At Con-Vey, we take pride in creating the right-fit solution for our customers, whether that is a full-scale new build, a custom integration, or a unique upgrade. Our solutions strike the right balance – time-tested, durable machines with modern technologies like robotics and operator-friendly automation. When you work with Con-Vey, we take on the responsibility of driving project momentum and making your job easier. We act as project stewards by listening and fully understanding your needs, then transparently guiding each phase of the process from concept through startup and beyond. Contact one of our Product Managers today at sales@con-vey.com to get started on your next innovative solution.

Contact:

Jon Stults – Sales Manager

Phone: 541-672-5506

Email: sales@con-vey.com

526 NE Chestnut Ave, Roseburg, OR 97470

www.con-vey.com

PLATINUM

COSTA Sanders LLC

Building on 60+ years of experience manufacturing industrial calibrating, sanding and polishing equipment, Costa's large panel series machines continue a tradition of rugged world-class machinery that made Costa an industry leader in the field of industrial sanding-calibrating equipment. These "super duty" solutions are engineered and manufactured to the highest quality standards, in modular frames, with the right combination of working units, motors, and feed speeds that best fits the industrial process of today and tomorrow. Costa Sanders offers machine solutions engineered expressly to fit each client's own manufacturing environment and production needs – whether particleboard, fiberboard, plywood, OSB, or CLT. Our sanding systems are capable of processing up to 145-inch-wide panels with thicknesses up to 13 inches.

Contact:

Eric Johnston - Sales Director, Panel Division

Phone: 336-434-6644

Email: eric.johnston@costasanders.com

107 Seminole Drive, Archdale, NC 27263

www.costasanders.com

SILVER

Dieffenbacher Customer Support, LLC

Dieffenbacher, an International Group of Companies, is an independent family business in its fifth generation. We've stood for reliable partnership and continuous progress for over 150 years. We are a leading manufacturer of press systems and complete production plants (including woodyard, sizing systems, energy systems [with or without co-generation], dryers, glue preparation, forming stations, forming lines, press [continuous or multi-opening] and finishing lines) for the wood-based panels industry, forming and recycling industries. In addition, we offer a wide range of advanced solutions for sustainable energy generation, via our Energy Systems Business Unit. Our Wood-based panel Business Unit plans and executes complete solutions from Service & Spare Parts, to Modernizations, to completed New Production lines. Our Wood division focuses on panel solutions for Oriented Strand Board (OSB), Oriented Strand Lumber (OSL), Particleboard (PB), Medium Density Fiberboard (MDF), Thin High Density Fiberboard (THDF), Laminated Veneer Lumber (LVL) as well as Wood Fiber Insulation Board (WFIB) and Continuous Plywood production. Let us see how we can Move Forward. Together.

Contact:

Colin Folco – Director, Modernization North America

Phone: 678-325-5815

Email: colin.folco@dieffenbacher.com

1345 Ridgeland Parkway, Suite 100,

Alpharetta, GA 30004

www.dieffenbacher.com

SILVER

DO2 Industriel

The DO2 Rapid Wrapper Automatic Panel packaging system offers outstanding performance. The wrapping machine's electrical, mechanical and pneumatic components, its design, the programming structure and tactile interface have all been designed for easy use and no-hassle operations. All of the wrapper's components are robust and maintenance-free. Built with durability and efficiency in mind, the wrapper will optimize your plant's production on a daily basis.

Contact:

Patrick Sasseville – Sales Representative

Phone: 1-888-276-0554

Email: psasseville@do2.ca

303 8th Avenue, Dolbeau Mistassini,
Quebec G8L 1Z6, Canada

www.do2.ca



GOLD

Dürr Systems, Inc.

Dürr Systems, Inc. offers multi-pollutant clean-air solutions to the engineered wood products industry that meet stringent emissions regulations: wet scrubbers and wet electrostatic precipitators for high-efficiency particulate, blue haze and condensed salts removal for dryers and press vents; ultra-high-efficiency RTO/RCO systems for VOC abatement, and SNCR systems for NOx control. The Dürr Systems aftermarket group also provides upgrades, parts, and service for every make of air pollution control equipment for the engineered wood products industry.

Contact:

Rodney Schwartz - Vice President CTS

Phone: 920-337-1461

Email: sales.cts@durrusa.com

830 Prosper Street, De Pere, WI 54115

www.durr.com

Electronic Wood Systems, N.A.

EWS North America was founded in 1993. We are a leading supplier of quality control measuring systems for the wood composite panel board industry, including: Thickness Gauges, Blow Detection, Press Protection Devices, Spark Detection & Extinguishment Systems, Mass (WPUA) Measuring, non-contact Weigh Scales and Density Profile Measuring Systems.

Contact:

Steven Mays - Partner

Phone: 503-643-6305

Email: steve@ews-usa.com

3720 SW 141st Ave #206, Beaverton, OR 97005-2349

www.ews-usa.com

Elite Automation Ltd.

Manufacturers of quality machines and automation / control systems.

Contact:

Todd Rogers – President

Phone: 604-435-7148

Email: todd.rogers@eliteautomation.com

Unit 1, 5707 Sidley Street,

Burnbay, BC V5J5E6

PLATINUM

Fagus GreCon, Inc.

Since 1911, Innovation is Our Tradition. MEASURING SYSTEMS: Improves your bottom line. Check out the full range of in-line measuring systems: thickness gauges, blow & delamination detector, moisture meters, raw density profile. Weight per unit area across the whole production width at the mat former and after the press. Detect surface defects on décor panels and flooring. SPARK DETECTION & EXTINGUISHING SYSTEMS: Provides safety for your production. Detect sparks and extinguish them before the filter. Detect heat buildup in silos, bag houses and storage bins. Outlined in NFPA 69, 654 and 664 standards. Factory Mutual Approved.

Contact:

Todd Havican

Phone: 704-912-0000

Email: sales@grecon.us

648-A Griffith Road, Charlotte, NC 28218

www.fagus-grecon.us



GOLD Flamex, Inc.

Flamex Inc. is a leading supplier of customized industrial process fire prevention and protection equipment. We specialize in the protection of facilities that handle combustible dusts that utilize pneumatic dust collection and air filtration systems. To address the process fire hazard inherent in various industrial applications, our company pioneered the utilization of a new technology in North America by introducing the FLAMEX Spark Detection and Extinguishing System in 1977 and the MINIFOG PressProtect System in 1997 for the protection of Industrial Presses. The flexibility of these systems allows their use in other hazardous areas such as Thermal and Hydraulic oil rooms where Fluorine-Free Foam FFF Fire Fighting systems can be utilized for further protection.

Contact:

Ed Pridgen - Vice President

Phone: 336-299-2933

Email: epridgen@sparkdetection.com

4365 Federal Drive, Greensboro, NC 27410-8116

www.sparkdetection.com

FROMM Packaging Systems

FROMM Packaging Systems for the lumber Industry consists of heavy-duty machinery. Our equipment covers all packaging solutions for the forestry industry (timber, plywood, MDF, HDF, chipboard etc) with strapping machines, wrapping and waterproof machines. We develop and produce a wide variety of systems for unitizing and palletizing goods for transport: strapping machines and systems, pallet stretch wrapping machines, together with all necessary consumables. Established in 1947, the Swiss company pursues a policy of logical vertical integration while upholding traditional values such as proximity to customers, quality consciousness, continuity, independence and environmental awareness, which are the reasons for decades of success.

Contact:

Francesco Belloni - Equipment Manager

Phone: 917-698-2052

Email: francesco.belloni@airpadusa.com

85 Fulton St, Unit #4, Boonton, NJ 7005

www.frommstrappingsystems.com



Engineered Solutions • Project Management • Complete Systems • Service and Support

Globe Machine Manufacturing Company

Globe Machine offers single machine centers along with complete systems to the following industries: OSB, MDF, particleboard, plywood, strawboard, moulded door skins, membrane presses, siding, LVL, laminate flooring and sheet plastics. Globe Machine is the leader in the supply of automated I-joist assembly systems and has achieved a leadership role in the cement fiberboard industry and moulded door skin lines. For 100 years Globe Machine has served the forest products industry.

Contact:

Mike Tart – Sales Manager

Phone: 253-383-2584

Email: sales@globemachine.com

701 East "D" Street (PO Box 2274), Tacoma, WA 98421

www.globemachine.com

Grenzebach Corporation

Grenzebach is a leading global manufacturer and supplier of drying systems for the veneer and building materials industries with over 400 dryer installations worldwide. Our veneer product line includes jet and longitudinal dryers, infeed and outfeed systems, and veneer grading and stacking systems. Grenzebach has completed extensive rebuilds and upgrades on all makes and models of veneer, allboard, and ceiling tile dryers. Grenzebach Service supplies complete parts and service (on-site and remote) for all building materials drying systems.

Contact:

Karl Aicher – Director, Engineering, Building Materials Division

Phone: 770-254-5024

Email: karl.aicher@grenzebach.com

10 Herring Road, Newnan, GA 30265

www.grenzebach.com

Guardian Chemicals Inc.

Providing solutions, results and meaningful service has earned Guardian Chemicals Inc. the enviable industry reputation as the “go to” people for chemical technology and services. Our extensive research and development group, in house ISO 14001 certified manufacturing and products like our revolutionary patented RESSGUARD series release agent technology for MDI resins in continuous and multi-opening presses, keep us at the forefront of the engineered wood industry. From W.E.S.P. and Scrubber treatment technology, process chemicals and defoamers to maintenance chemicals, odor control and corrosion prevention, Guardian’s wood group provides our partner clients with a complete package along with the flexibility to adapt products to the specific needs of each individual application and customer.

Contact:

Greg Pecharsky - Vice President of Sales (Canada)

Phone: 780-998-3771; 800-661-6544, Ext. 211

Email: gpecharsky@guardianchem.ca

155 - 55202 SH 825 Surgeon Industrial Park, Sturgeon County, AB T8L 5C1, Canada

www.guardianchem.com

Hashimoto Denki Co., Ltd.

Hashimoto Denki Company, Ltd was established in 1946 in Nagoya, Japan, the Japanese woodworking machinery capital. Our company specializes in manufacturing machinery for high-efficient and value-added plywood and veneer production, ranging from veneer lathe lines to panel sizing lines. We offer machinery for total plant operation of veneer, plywood and LVL, serving the worldwide marketplace.

Contact:

George Mori - General Manager

Phone: +81-566-53-6902

Email: mori-j@hdk-co.com

5-1-17 Shinden-cho, Takahama-City, Aichi Pref.
44-1301, JAPAN

www.hdk-co.com/english

HAWE Hydraulik

HAWE Hydraulik is a well-respected, worldwide, German based company with offices in over 20 countries. HAWE’s primary business is providing high quality hydraulic components through modular design and energy efficient solutions. HAWE offers a full range of products from high pressure valving to custom hydraulic units and manifolds to complete hydraulic systems including motion controls. We are a complete solutions provider.

Contact:

Steve Kathan - Industrial Group Manager

Phone: 503-222-3295

Email: s.kathan@hawe.com

12990 SE Highway 212, Clackamas, OR 97015

www.hawe.com

HexArmor

HexArmor is a global PPE (personal protective equipment) manufacturer that uses innovative technologies to build high performing hand protection, arm/body protection and eyewear. At HexArmor, we understand the daily challenges faced by safety teams in the wood products industry. Working to meet growth and operational expectations while keeping employees safe on the job can be a tough balancing act. Injuries are costly. Down time and lost productivity damage company reputations and slow growth. Let HexArmor help you build a PPE program that keeps you operationally efficient while giving your employees the best opportunity to go home safely to their families.

Contact:

Patrick Beadling - Director of Strategic Accounts

Phone: 616-459-4144 Ext. 100; 616

Email: patrick@hexarmor.com

2000 Oak Industrial Drive, Grand Rapids, MI 49505

www.hexarmor.com

IBC, International Bar Coding Systems & Consulting Inc.

IBC, International Bar Coding Systems & Consulting Inc.
– An integrated manufacturer of individual piece wood product specific printer applicators. Complete solutions for finished or in-process packs we offer Automated Package labelers (AutoLabeler) for Veneer, OSB, MDF, Plywood, Lumber and EWP. We manufacture tags and labels for any labeling system and are a single source provider for turnkey solutions. We offer Vendor Managed Inventory of consumables and integrated data collection systems across North America. We provide full design, build, onsite service, preventative maintenance, training and consulting on a system wide or mill by mill basis.

Contact:

Chris Pedersen - President

Phone: 250-493-3201

Email: cpedersen@ibcworld.net

160 Satikw Crossing, Penticton, BC V2A 6J7 Canada

www.ibcworld.net

IMA Schelling Group

IMA Schelling Group is a single-source provider of sales, service and support of IMA and Schelling machinery and software. We offer customers and business partners the benefit of working with one source for customized industrial engineering, manufacturing and machinery sales under a single roof in Raleigh, North Carolina. IMA Schelling Group works collaboratively with North American businesses. Our customers range from mid-size operations to major corporations.

Contact:

Christina Griggs - Sales & Product Marketing

Phone: 919-544-0430

Email: marketing.us@imaschelling.com

301 Kitty Hawk Drive, Morrisville, NC 27560

www.imaschelling.us

IMAL-PAL Group

Established in the 1970's, the Group is a world leader in the manufacture and supply of equipment and systems. It's extensive production program is able to supply complete turnkey plants for the treatment and processing of fresh and recycled wood, in both the wet and dry areas, for production and processing of particleboard, MDF, OSB, Plywood, Pellets, Pallet Blocks and pressed wood-based products in general. IMAL is a leading manufacturer of glue dosing and blending systems and supplies the most innovative on-line and laboratory quality control devices that are found in virtually all the production plants around the world.

Contact:

Andrew Jowett - President

Phone: 509-855-3411

Email: andrew.jowett@imalpal.com

2066 Airport Industrial Park Drive,

Marietta, GA 30060

www.imalpal.com



IMEAS Inc.

Providing world-class surface finishing solutions for more than 55 years, IMEAS has over 3,000 machines operating worldwide. IMEAS sanding and grinding machines allow facilities to achieve precise surface finish and thickness on a wide variety of engineered wood products such as glulam, plywood, LVL, CLT, decorative laminates, flooring and other solid surface products. IMEAS specializes in 12 ft. (3.6 m) extra wide cross-belt and four-sided sanding systems, giving IMEAS a lead position in sanding glulam beams.

Contact:

Bryan Wolowiecki - President

Phone: 678-364-1900

Email: imeas@imeas.us

1415 Senoia Road, Suite A,

Tyrone, GA 30290

www.imeas.us



SILVER Itipack Systems

Itipack Systems is a world leader in integrated automated strapping solutions since 1970. Each one of our systems shares in our firm commitment towards high value, optimum performance, and long-lasting results. We provide custom solutions to industries with specific and unique manufacturing requirements.

Contact:

Dan Hulzebosch - Vice President of Sales & Business Development

Phone: 905-681-3630, ext. 243

Email: dhulzebosch@itipacksystems.com

919 Zelco Drive, Burlington, ON L7L 4Y2, Canada

www.itipacksystems.com

SILVER Kadant Carmanah Design

Kadant Carmanah provides leading edge technology and equipment to optimize fibre utilization for the production of wood-based panels. Kadant Carmanah's products include SmartRING Stranders, SmartDISC Stranders, Rotary Debarkers, and Conveying/Feeding equipment for the OSB market – all backed by our best-in-class engineering, manufacturing, installation, service, and parts support teams. Recognized as the global leader in stranding technology, Kadant Carmanah holds an impressive 80% of this market share.

Contact:

Carlos Vieira - Director, Engineered Wood Sales

Phone: 604-268-1698

Email: carlos.vieira@kadant.com

Unit #8 – 15050 – 54A Avenue,
Surrey, BC V3S 5X7, Canada

www.kadantcarmanah.com

Kimwood Machinery, Inc.

World's leading producer of new equipment and OEM parts for Kimwood Sanders, Hogs and Handling Equipment, Stetson-Ross Planers and Moulders, Ferrari Resaws and Tri-State Equipment.

Contact:

Scott Carle - Forestry Operations Manager

Phone: 604-835-1045

Email: sales@kimwood.com

77684 Highway 99 South, Cottage Grove, OR 97424

www.kimwood.com

Knight Material Technologies

A domestic manufacturer and global leader of ceramic media for Regenerative Thermal Oxidizers (RTO). Our media is designed to work in normal to your most challenging application environments. A mixed bed of our FLEXERAMIC® structured media and LPD® random media offers optimal heat transfer and full bed utilization while our GR (Glazed Resistant Alumina) material is produced for OSB Dryer and other applications for the wood products industry. We manufacture our ceramic media domestically and have many sizes in stock at our East Canton, OH facility.

Contact:

Mindy Schmittle

Phone: 330-488-1651

Email: mindy.schmittle@knightmaterials.com

5385 Orchard View Drive SE, East Canton, OH 44730

www.knightmaterials.com

LIMAB North America

LIMAB supplies non-contact laser measuring systems for composite panels and engineered wood products, including thickness and squareness measurements, and blow detections on panels.

Contact:

Michael Spurgin

Phone: 865-243-9245

Email: michael.spurgin@limab.com

3122 Fincher Farm Rd., Suite 722

Matthews, NC 28105

www.limab.com

SILVER **LDX Solutions**

LDX Solutions is a global supplier of air pollution control, process improvement technologies, pneumatic conveyance, energy conservation solutions, and aftermarket support & services for heavy industry. Through our portfolio of branded products & services, we have thousands of installations and are cleaning the air in over 20 countries and over 50 different industries.

Contact:

Frank Bryant – Head of Marketing

Phone: 770-429-5575 Ext . 234

Email: fbryant@ldxsolutions.com

60 Chastain Center Blvd NW, Suite 60,

Kennesaw, GA 30144

www.ldxsolutions.com

**LEDINEK**

LEDINEK is global leader in Cross Laminated Timber (CLT), Glulam Beam and finger jointed Solid Timber technology. Knowledge of mechanical engineering and practical experience in mass timber solutions gained over decades combined with our SOTA equipment, allows us to equip you with individually optimized complete solutions in engineered wood production. From concept and design, to installation, training and commissioning, we provide the leading finger jointing and panel & beam press technology, state of the art planing, moulding, sawing and splitting solutions, material handling equipment, data flow management and excellent aftersales support for you. We cherish our partnerships - Count on us!

Contact:

Andrej Holc - Sales Engineer

Phone: 00386 2 613 00 51

Email: andrej.holc@ledinek.com

Slivniška cesta 18, HOČE, 2311, Slovenia (EU)

www.ledinek.com

DIAMOND **Matthews Marking Systems**

Matthews Marking Systems, established in 1850, is a leading supplier of marking and coding equipment for the engineered wood and building products industries. Matthews supplies ink jet printing solutions for applications including grade marking, nail patterns, traceability and large format logo printing. We also offer a variety of inks, specific to the wood industry, including water based, fast dry and VOC free.

Contact:

Bill Ashley - Key Account Manager

Phone: 704-467-9682

Email: bashley@matw.com

3159 Unionville Rd, Suite 500,

Cranberry Township, PA 16066

www.matthewsmarking.com

DIAMOND **Meinan Machinery Works, Inc.**

Established in 1953 in Japan, Meinan develops and manufactures innovative machinery for veneer and plywood production, and holds hundreds of worldwide patents. Meinan's revolutionary "spindleless" lathe drives logs on their circumference with spiked discs instead of spindles, resulting in better veneer quality, higher recovery, and extremely close thickness tolerance. The lathe is part of an automatic veneer peeling line featuring automatic knife changing, automatic stacking, and green composing of random width veneer to save labor costs and increase dryer utilization. Meinan also manufactures scarf composers, grading systems, automatic layup lines, and sanders. Represented in USA by Merritt Machinery, LLC in Lockport, NY.

Contact:

Jimmy Nakaya - Sales Director

Phone: 716-434-5558

Email: t.nakaya@meinan.co.jp

U.S. Representative:

Anna McCann - President

Email: amccann@merrittmachinery.com

10 Simonds Street, Lockport, NY 14094

www.merrittmachinery.com

Mereen-Johnson LLC

Mereen-Johnson has been setting the standard for the woodworking and engineered materials industries since 1905 and offers a complete line of Gang Rip Saws, Profiling Machines, Cross Cutting Equipment, Sizing Systems, I-Joist equipment, and related material handling designed for reliable, high speed production with minimal maintenance. Mereen-Johnson also offers a complete line of solid wood processing equipment such as fixed arbor and shifting blade straight line multiple Rip Saws, Rough Mill Optimizing and Material Handling, Moulders, Single and Double End Tenoners, CNC controlled Dovetailers, and Box Clamps.

Contact:

Dave Olson - Corporate Sales Manager

Phone: 612-529-7791

Email: info@mereen-johnson.com

5201 East River Road - Suite 301,
Minneapolis, MN 55421

www.mereen-johnson.com

SILVER

Mill Machinery LLC

Mill Machinery is a provider of new and reconditioned machinery to the veneer and panel industries. Mill Machinery's inventory of production machinery includes veneer lathes, veneer stackers, dryers, plywood presses, sawlines, grade bins, panel feeders, sanders, hogs and related support equipment. Mill Machinery's Magnum line of new machinery includes press loading/unloading systems, press platens, hydraulic units, flying saws, panel feeders, panel stackers and conveyors.

Contact:

Tim Peterson - President

Phone: 503-720-0540

Email: tim@millmachinery.net

31678 South Highway 213, Molalla, OR 97038

www.millmachinery.net

MINDA North America, LLC

MINDA has been meeting customer needs in the engineered wood industry for more than 40 years, providing leading technology for laminated timber processes. Whether the application requires custom press technology, material handling, data flow management, or overall plant development, MINDA provides specific solutions from concept and design to installation and commissioning. MINDA is a global supplier of flexible, high speed presses for Cross Laminated Timber (CLT), Glulam Beam, and LVL Beam applications. Headquartered in Minden, Germany, with our latest expansion of a full-service manufacturing facility located in Granite Falls, North Carolina, USA.

Contact:

Charles Martin - President & CEO

Phone: 828-313-0092

Email: c.martin@minda.com

10 N. Summit Ave., Granite Falls, NC 28630

www.minda.com

PLATINUM

NESTEC, Inc.

Founded in 1999, NESTEC is a global leader in VOC and HAP emissions control. NESTEC provides innovative pollution management and abatement technologies for a range of industries, including specialty chemicals, wood products, ethanol, and building products. NESTEC's solutions control carbon monoxide, wood dust particulate, condensable organic aerosols, alkali metal containing ash, and water-saturated air streams. NESTEC engineers have treated emissions for over 25 years in plywood, particleboard, oriented strand board (OSB), and wood pellet plants.

Contact:

James L. Nester - President

Phone: 610-323-7670

Email: jnester@nestecinc.com

222 East Main Street, Pen Argyl, PA 18072

www.nestecinc.com

Nextwire

Nextwire is a North American company with over 50 years of manufacturing and engineering experience in woven fabrics for the Engineered Wood Industry. Nextwire CleanSheen II caul and press screens have greatly impacted the industry with extended life resulting in lower cost per board foot. Nextwire can provide these screens with attached tow bars which are manufactured from stainless or plain steel. All caul screens, press screens, and tow bars are manufactured to individual mill site specifications. Nextwire also manufactures preheater, intermediate and tray belts as well as a variety of products in stainless steel and synthetic material.

Contact:

Charlie Brown - VP of Sales

Phone: 870-628-6378

Email: cbrown@next-wire.com

701 E. Arkansas Ave. (PO Box 159), Star City, AR 71667

www.next-wire.com

Nicholson Manufacturing Ltd.

Industry Leader in ring debarking technology since 1948.

Contact:

John Jennings – Director of Capital Sales

Phone: 250-655-7508

Email: forestsales@nicholsonmfg.com

9896 Galaran Road, (PO Box 2128),

Sidney, BC V8L 3S6, Canada

www.debarking.com

GOLD **Radian Robotics**

Radian Robotics is a turn-key provider of Quality driven, Automated Material Handling systems for the OSB and Plywood industries. We focus on Safety, Reliability and strong Customer relations, ensuring that all Customer Needs are met before, during and after, final installation. From initial Quotation to system Support and Service, Radian Robotics delivers prompt, Quality solutions.

Contact:

Shayne Baker - Quality Manager

Phone: 905-639-7370

Email: sbaker@radianrobotics.com

70 Lancing Drive, Hamilton, ON L8W 3A1, Can

www.radianrobotics.com

SILVER **Raute**

At Raute, we have global expertise in wood products manufacturing and we are technology and innovation leaders. Raute invests in advancing the production process of plywood, LVL, and engineered wood products. Raute provides profitable solutions for large mill-wide projects, individual process lines, equipment upgrades, spare parts and service. Raute is your partner in production performance.

Contact:

Trevor Wendt - Vice President Sales, NAM

Phone: 604-619-0029

Email: trevor.wendt@raute.com

1633 Cliveden Avenue, Delta, BC V3M 6V5 Canada

www.raute.com

SILVER **REA JET**

REA JET has been a global leader of coding and marking solutions for the engineered wood industry for over 30 years. Whether you're looking to print APA grade stamps, large logos & graphics, 2D scannable barcodes or nail grid patterns, REA JET has flexible and reliable systems designed to run at high speeds and hold up in the harshest environments. Contact REA JET today to learn more about our products and capabilities for all of your traceability needs.

Contact:

Nicole Richie - Marketing Manager

Phone: 678-205-5962

Email: sales@reajetus.com

7307 Young Drive, Walton Hills, OH 44146

www.reajetus.com

Samuel Packaging Systems Group

With over 50 years serving the lumber and forest products industry, Samuel Packaging Systems Group, offers their customers in the Engineered Wood industry a single source supply for all of their strapping, ink jet printing, labeling, and packaging requirements. Samuel's product line includes steel and plastic strapping, pneumatic and manual hand tools, seals, edge protection, fully automated strapping systems. Our industry leading VK-30 strapping head has been used in both new and retrofit applications to convert our customers from steel to polyester strapping. Samuel is a leader in strapping for engineered wood products and had the first AAR approved polyester strapping. The Product Identification Division provides fully automated systems for ink jet printing for grade and marketing requirements, as well as piece and package labeling for identification, tracking and shipping.

Contact:

Bob Hadden - North American Forestry Manager

Phone: 800-667-1264

Email: bob.hadden@samuel.com

2278 - 192nd Street, Unit 109,

Surrey, BC V3Z 0N2, Canada

www.samuelstrapping.com

SILVER

Siempelkamp LP

Siempelkamp is a systems supplier of complete process equipment for the wood-based-panel industry. In addition to the ContiRoll generation 9 Continuous press, Multi-opening presses, as well as sanding, cut to size and stacking lines for the panel board industry, Siempelkamp provides the full range of process machinery. With its subsidiaries Sicoplan, the engineering company for complete plant engineering; Pallmann for debarking lines, chippers, stranders, and other size reduction machinery; Buettner for energy systems, dust and multi-fuel burners and dryer systems, the complete process machinery portfolio is covered. Siempelkamp LP provides the service support, modernizations and spare parts for North America.

Contact:

Dirk Koltze - President

Phone: 704-424-4141

Email: d.koltze@siempelkamp-usa.com

200 N. Cobb Pkwy., Suite 302, Marietta, GA 30062

www.siempelkamp-usa.com

Signode Packaging Systems

Signode is a global manufacturer of steel and plastic strapping and the application equipment and accessory products for each. Our protective packaging systems for the Lumber and Panel Industries are centered around the material that ultimately secures loads for handling, shipping and storage, plastic or steel strapping. We offer a full range of application tools, equipment and accessories to complete your strapping system. Our Forest Products Industry sales, equipment service, customer service and engineering departments can help you design the optimum protective packaging system for your application.

Contact:

Mark Smanda

Phone: 704-907-0533

Email: msmanda@signode.com

3624 West Lake Avenue, Glenview, IL 60024

www.signode.com

SMARTECH

SMARTECH is a hi-tech company that develops software solutions and production equipment to propel wood-based panel manufacturers to new heights. Our Autonomous ManUFACTURING™ AI-based software and Smart ManUFACTURING™ Systems (patented technology) help manufacturers to dramatically improve critical processes and reduce significantly the use of raw material.

With the use of Artificial Intelligence, SMARTECH connects people, plants and processes and brings autonomy to critical production processes to maximize output, quality and efficiency in the plant while saving costs.

SMARTECH is recognized as a trusted partner for the world's leading manufacturers in the engineered wood industry.

Contact:

Hanoch Magid - CEO

Phone: 972-4-6377757

Email: hanoch.magid@smartech.com

7 Chalamish St., Caesarea, 30889, Israel

www.smartech.com

GOLD

SonicAire

SonicAire is a progressive air-engineering firm that eliminates the problems with combustible dust through its line of SonicAire® fans. SonicAire Systems apply our proprietary and innovative BarrierAire™ technology, which delivers enterprise-wide continuous clean through robotic engineering design. Products create high velocity and high mass airflow to create an overhead barrier preventing combustible particles from accumulating on steel structures, pipes, ducts and process equipment. Solutions include an engineered and customized plan for every application since factories AND fugitive particles vary by the materials processed. Contact SonicAire Sales support at 336-712-2437.

Contact:

Chuck Morrison - Vice President of Sales

Phone: 336-712-2437

Email: cmorrison@sonicaire.com

3831 Kimwell Drive, Winston-Salem, NC 27103

www.sonicaire.com

SILVER

SparTek Industries

SparTek Industries manufactures high quality machinery with the latest cutting edge technology for many industries including Plywood, LVL, Rubber and others. Today's high volume Plywood production Lay-Up Lines place an emphasis on efficiency. SparTek's lay-up lines, Hot and Cold Presses, Loading and Unloading equipment, Glue Application systems and other equipment are designed to meet these demands. Helping customers meet and exceed their production and operating goals is a driving force at SparTek. We are here to help you meet your goals and to do so requires innovative technology and machines designed to work at the highest operating speeds.

Contact:

Mike Cook - CEO

Phone: 503-283-4749

Email: mike.cook@spartek.com

2221 North Argyle, Portland, OR 97217

www.spartek.com

GOLD

Spraying Systems Co.

Spraying Systems Co. is the world's leading manufacturer of spray technology equipment. Our offering includes a family of PanelSpray® systems for applying release agents, moisture, resin, wax or other various chemistries to wood substrate, mats, cauls or belts. These systems ensure the precise volume of fluid is applied even when operating conditions like wood throughput or line speed change. Our line also includes a PanelSpray System for precise nail marking on oriented strand board and the industry's largest selection of spray products for use in humidifying, marking, cleaning and coating operations. We serve our customers around the world from our 12 manufacturing facilities and 90 sales offices.

Contact:

Brian Valley - Director - Industrial Solutions

Phone: 630-517-1283

Email: brian.valley@spray.com

100 W. Lake Dr., Glendale Heights, IL 60139

www.spray.com

SILVER

Stela Drying Technology Corp.

Companies looking to optimize their drying processes have turned to Stela for over 4,000 successful installations worldwide. Our 100-year-old company is the most forward-looking, innovative belt dryer manufacturer in the world. Precision, dependability and knowledge is what you get when belt dryers is all you make. If your North American project needs an energy efficient, low emission, and low maintenance belt dryer for biomass drying in an OSB, particle board, wood pellet, or any other plant, let us tailor a successful solution for you.

Contact:

Wedig Graf Grote - VP Sales North America

Phone: 470-574-4711

Email: wedig.grote@stela.de

271 17th St. NW, Suite 1750, Atlanta, GA 30363

www.stela.de

SILVER Stiles Machinery

Stiles Machinery, a proud member of the HOMAG Group, offers complete-system, best-in-class machinery solutions for the primary manufacture and secondary fabrication of all Solid Wood and Engineered Wood Products, and for off-site Building Automation systems. This includes infeed and outfeed material handling; lumber grading, scanning, and finger-jointing; high-speed pressing and CNC fabrication of structural Mass Timber Beam and Panels, as well as Sawing, Sanding, Moulding, Edgebanding, and CNC machining for the Solid-Wood and Composite Panel Industries. Backed by the nation's largest team of 24/7 service and support specialists, an extensive inventory of ready-to-ship parts, and the industry's only nationally accredited workforce training program (StilesUniversity.com).

Contact:

Roland Hernandez – Vertical Market Manager,
Mass Timber - North America

Phone: 616-698-7500

Email: rhernandez@stilesmachinery.com

3965 44th Street SE, Grand Rapids, MI 49512

www.stilesmachinery.com

PLATINUM Sweed Machinery, Inc.

SWEED is known in the industry as the superior choice for providing full veneer dryer infeed and outfeed systems, dry, green, and random veneer stackers, veneer saws, turners, and hoists. SWEED also specializes in all replacement parts for Raimann and Skoog patchers and manufactures, sharpens, and repairs patcher dies. SWEED provides the latest technology and exceptional craftsmanship, helping processors achieve higher production goals with less downtime. SWEED is based in Oregon, USA, and has served the industry for over 65 years; SWEED continues its legacy in offering unmatched quality, customer service, engineering, and technical support.

Contact:

Kevin Gordon - Sales Director

Phone: 541-855-1512 Ext. 5926

Email: kgordon@sweed.com

653 2nd Avenue (PO Box 228), Gold Hill, OR 97525

www.sweed.com

PLATINUM Taihei Machinery Works Ltd.

Taihei is a specialized manufacturer of veneer and plywood machinery, fully committed to the development and production of equipment that meets customer needs. We are driven by the goal of providing proprietary machinery that is second to none to our customers around the world. Taihei is the leading manufacturer of automatic knife grinding and honing machines. Other Taihei products include horizontal hot presses up to 140 openings, veneer jet dryers, veneer stackers, glue spreaders, reeling systems, and finger jointing equipment.

Contact:

Sam Matsuoka - Sales Department, Export

Phone: +81-568-73-6421

Email: h_matsuoka@taihei-ss.co.jp

955-8 Miyamae, Komaki, Aichi 4850084, Japan

www.taihei-ss.co.jp

GOLD TSI

TSI designs and manufactures complete panel finishing lines for OSB, particleboard and MDF. This includes saws with such features as automatic position change and adjustable blade exposure. High-speed sorting and stacking of panels is easily achievable with TSI's "primary stacker" solution. TSI also supplies Heat Energy and Drying and Pollution Control Systems for OSB and Particleboard based on Single Pass Recycle technology. The Dryers are proven to increase productivity and reduce emissions compared to other systems. Heat Energy includes Step Grate Furnaces in conjunction with Sigma Thermal and Pollution Control solutions include Wet ESP and RTO systems developed by TSI to work at optimum efficiency with TSI Dryers.

Contact:

Andrew Johnson - Vice President

Phone: 425-771-1190 Ext. 128

Email: ajohnson@tsi-inc.net

20818 44th Avenue West, Lynnwood, WA 98036-7709

www.tsi-inc.net

USNR

DIAMOND USNR

With the addition of Ventek's veneer scanning, grading, and handling solutions to USNR's lathe, dryer, and downstream product portfolio, USNR now offers tightly integrated mechanical and optimization solutions for the plywood industry. USNR products are known to increase recovery, value, and yield, improving mill profitability. USNR also manufactures machinery for beam lamination, finger-jointing, and presses for the composite board industry. Committed to superior customer service, USNR offers OEM parts, training, and 24/7 support around the globe. 800-BUY-USNR.

Contact:

Chris Van Ackeren - Sales Manager, Veneer Systems

Phone: 541-284-5465

Email: chris.vanacker@usnr.com

Sam Pope - North American Sales Manager,
Chop & Rip, and Mass Timber Systems

Phone: 360-225-8267

Email: sam.pope@usnr.com

1981 Schurman Way (PO Box 310)

Woodland, WA 98674

www.usnr.com

Venango Machine Company, Inc.

Venango Machine and our sister company, Custom Engineering, are complete platen services providers to the forest products industry. We provide new platens for every make of press in the industry for manufacturing of all board products. Our product line includes small specialty platens for lab applications, intermediate sized platens for particle board, OSB, and LVL in both multiple platen and continuous processes. We also provide complete platen-refurbishing programs that include flow and pressure testing, weld repair and re-machining to original specifications. Our technicians also provide assistance in platen change outs and in-press weld repair. Please contact us for all your platen requirements.

Contact:

Nyla Vogel - Sales Manager

Phone: 814-739-2211

Email: nvogel@venangomachine.com

PO Box 239, Wattsburg, PA 16442-0239

www.venangomachine.com

PLATINUM

Westmill Industries USA Corp.

For 47 years, WESTMILL® has remained laser-focused on advancing Veneer Dryer design through continuous innovation. After years of effort and determination, WESTMILL® has emerged as the industry leader in this field. Whether you urgently require a custom component for your dryer's infeed or outfeed, or you need us to provide an entire installed 'turn-key' dryer and stacker line, WESTMILL® will respond immediately with your best interest in mind. Always. WESTMILL® has the necessary consulting and engineering services to help solve any problem. To minimize customers' inventory requirements while keeping your dryer operating in tip-top condition, WESTMILL® has replacement parts available for every make and model of board-dryer with inventory at dedicated warehouses in Oregon, Georgia, and Vancouver, B.C. (WESTMILL® is the largest stocking supplier of replacement dryer parts in the world.) Don't put up with slow service, high pricing, and long deliveries. Instead, call the small company focused on delivering competitive value Dryer Technology. When we say "we've got your back" we mean it. Try us out.

Contact:

Mike Crondahl - President, Owner

Phone: 604-607-7010

Email: crondahl@westmill.com

30640 Marshall Road

Abbotsford, BC V2T 6J7 Canada

www.westmill.com

SILVER

WPS Industries/ Eagle Project Services

WPS Industries is a full service fabrication and installation provider for Wood Products, Biomass, Oil & Gas, Environmental, Power and various other industries. Eagle Project Services provides detailed engineering and project management services to the same noted industries.

Contact:

Jeremy Clark - Business Development

Phone: 318-243-0862

Email: jeremy.clark@iss-na.com

228 Industrial Street, West Monroe, LA 71292

www.iss-na.com

**Go to the online Equipment and Tooling
directory for additional details.**

MATERIALS AND SUPPLIES

The following EWTA members provide support in one or more of the following subcategories: Adhesives/Resins; Binders/Extenders/Fillers; Chemicals/Additives/Coatings; Lamstock/Lumber; Replacement Parts and Supplies; Specialty Supplies; Strapping and Packaging Supplies; Veneer/Overlays; Wax/Release Agents/Lubricants/Emulsions .Go to the online Materials and Supplies directory .

ACMOS, Inc.

ACMOS is a global technology leader specializing in high-quality release agents, lubricants, grinding coolants, and cleaning agents for various industries, including polyurethanes, composites, glass, and wood processing. With a focus on the wood industry, we excel in developing and producing top-tier release agents for applications like panel board manufacturing, paper impregnation, edge banding, laminating, veneering, cabinetry, and more. Through close collaboration with customers, we provide innovative, high-performance solutions to optimize manufacturing processes. Our worldwide presence ensures prompt and expert service, reducing cleaning and machine downtime for cost-effective operations and significant savings.

Contact:

Alyssa Boehringer – Marketing Manager

Phone: 724-220-6644

Email: info@acmosinc.com

5000 Stonewood Drive, Suite 200, Wexford, PA 15090

www.acmos.com

Albany International

Albany International is a global advanced textiles and materials processing company founded in 1895. We are headquartered in Rochester, New Hampshire and employ approximately 5,000 people worldwide. Our 26 manufacturing operations are strategically located in 13 countries to serve our global customers. Albany International's core business is production of custom-designed engineered fabrics and process belts, used to manufacture all grades of paper from lightweight technical paper to heavyweight container board. In its family of emerging businesses, Albany belting technologies process unique materials for engineered wood products particularly for wood forming in OSB, PB and MDF/HDF manufacturing. Visit us @Albint.com.

Contact:

Tom Israel - Product Manager-Americas

Phone: 920-521-4618

Email: tom.israel@albint.com

3601 Electric City Blvd., Kaukauna, WI 54130

www.albint.com

GOLD **Arclin - Performance Applied**

Based in Roswell, Georgia, Arclin is a leading producer of innovative bonding and surfacing solutions for the building and construction, industrial materials and natural resource markets. Arclin provides bonding solutions for a number of applications including structural wood panels, engineered wood, composite wood panels, non-wovens and paper saturation. As a world leader in paper overlays technology, Arclin provides high value surfacing solutions for construction and building products, decorative panels and industrial specialty applications for North American and export markets. For more information please visit www.arclin.com.

Contact:

Athena Tuohey – Sr. Business Director, Wood Products

Phone: 678-781-2962

Email: athena.tuohey@arclin.com

1000 Holcomb Woods, Parkway, Suite 342,

Roswell, GA 30076

www.arclin.com

Arxada

Arxada is a global leader in the development and supply of innovative technologies to improve the performance of wood products, making them resistant to termites, fungi, fire (flamespread and smoke development), mold and moisture. Arxada offers formulations specifically designed for the treatment of engineered wood, including Permatak® glueline treatments designed to work in harmony with resins as well as water repellents and mold prevention treatments to keep EWPs bright. Additional Arxada products include Wolman® residential preservatives, SillBor® borate treatments, Wolmanac® CCA and Chemonite® ACZA industrial preservatives, Dricon® fire retardants, FrameGuard® mold inhibition, and AntiBlu® anti-sapstain line. With global operations and an unparalleled offering of services and expertise, Arxada is dedicated to the success of its customers.

Contact:

Robert Dennison - Associate Director, Western and Canadian Sales

Phone: 503-969-7741

Email: robert.dennison@arxada.com

Vancouver, WA

www.wolmanizedwood.com

Axalta Coating Systems

With a wide range of products and technologies, Axalta Coating Systems is the leader in the Wood Coatings Industry for the Building Products market.

Contact:

Craig Lyerly - Director, Sales

Phone: 336-802-4746

Email: craig.lyerly@axaltacs.com

1717 English Rd., High Point, NC 27104

www.axaltacoatingsystems.com

PLATINUM **Bakelite Synthetics**

Bakelite Synthetics offers a portfolio of thermosetting resins for plywood, OSB and LVL applications as well as custom-formulated solutions to meet our customers' specific needs. Our innovative new RESI-BOOST® Gen2 adhesive technology, when used with Bakelite resins, has demonstrated significant advantages in increased throughput, lower applications rates and energy savings while maintaining performance, potentially saving or generating millions of dollars per plant. In addition, our Customer Inventory and Prediction Service offers our customers a means of maximizing operational efficiency by optimizing resin order profiles. The Dynamic Microchamber performs formaldehyde emission testing on panels in plants around the world.

Contact:

Caitlyn Sahlfeld, Sales Coordinator

Email: Caitlyn.sahlfeld@bakelite.com

Phone: 785-656-4808

1040 Crown Pointe Parkway, Atlanta, GA 30338

www.bakelite.com

BASF - We create chemistry

BASF - We create chemistry -- Global supplier of MDI to the wood industry with extensive experience in MDI conversions.

Contact:

Gregory Lonc - Business Manager, Rigid Urethane Chemicals North America

Phone: 732-324-6837

Email: gregory.lonc@basf.com

1609 Biddle Avenue, Wyandotte, MI 48192-3736

www.basf.us

Bates and Company, Inc.

Bates & Co. is an industry leader in providing various support products to the forest product industry. Extenders and fillers comprise the majority of sales, especially those customers extending phenol formaldehyde adhesives for use in plywood, LVL, and hardwood. Bates has also expanded its scope and reach by forming a joint venture, Bates-Willamette, LLC, with a strategic partner in the industry.

Contact:

Jim Gilliam - President

Phone: 409-883-0384

Email: jgilliam@cdbates.com

707 West Front Ave (PO Box 1328) Orange, TX 77631

GOLD **BOSTIK**

ISOSET™ adhesives from Bostik have been specially formulated for engineered wood product applications. ISOSET adhesives applied in I-joist, glulam beams and structural finger jointing wood applications provide manufacturers with high-strength, structural bonds. They cure fast, clean up easy and dry in a neutral wood color offering an alternative to traditional phenol-resorcinol-formaldehyde (PRF) - type adhesives. ISOSET adhesives provide excellent resistance to moisture, elevated temperature and creep making them an ideal choice for engineered wood products. Bostik is a part of the Arkema Group, a Global leader in the chemical industry, providing products, services and customer solutions throughout the world.

Contact:

Tom Stewart – Regional Business Director,
Building Components

Phone: 614-531-1077

Email: Thomas.stewart@bostik.com

5550 Blazer Parkway, Suite 350,

Dublin, OH 43017

www.bostik.com

Chem-Trend LP

Chem-Trend has long been known as a global leader in the development of release agent technology to the world's industries. Our sealers, release agents and lubricants are rapidly gaining acceptance in the wood composites industry, offering significant productivity improvements including increased through-put, improved output quality and definition, cleaner conditions/environment, greater productivity, less downtime and increased costs savings.

Contact:

Gerard Przekop - Director, North American Sales

Phone: 517-545-7844

Email: gprzekop@chemtrend.com

1445 West McPherson Park Drive (PO Box 860)

Howell, MI 48844-0861

www.chemtrend.com

Clarke Veneers and Plywood

Clarke Veneers and Plywood is an international trading company of wood products, specializing in imports, exports and domestically traded veneers - including hardwood and softwood species for structural panels, in MDO, HDO and other applications requiring clear, sound faces.

Contact:

Stuart Clarke - President

Phone: 601-366-0331

Email: info@clarkeveneers.com

3000 Old Canton Road, Suite 335 (PO Box 4876)

Jackson, MS 39216

www.clarkeveneers.com

Dominion Chemical Company, Inc.

Wax products are our expertise. With over 60 years of experience in the wax business, Dominion Chemical offers rare and valuable working knowledge as well as trust and proven abilities to bring solutions, support and alternatives to provide the exact product you want. With locations in Virginia and Georgia, Dominion Chemical's capacity to blend, package and create specialty wax formulations will meet your unique needs. We offer an exceptional emulsification process, state of the art blending, compounding, packaging and experienced personnel as well as a full service wax lab dedicated to your needs for R&D, QC, and general product evaluation.

Contact:

Maclin Ferrell - President

Phone: 804-733-7628

Email: maclinferrell@dominionchemical.com

Dan Spurlock - Sales Manager

Phone: 804-586-2022

Email: dans@dominionchemical.com

2050 Puddledock Road (PO Box 1069)

Petersburg, VA 23803

www.dominionchemical.com

Evertree North America Inc.

Evertree North America Inc. is the designer, manufacturer and supplier of a family of bio-based and renewable adhesive solutions (both unique bio-based adhesive compositions plus innovative application dispensing technology) used in the manufacture of composite wood panels. We are revolutionizing plant-based adhesive solutions for a better and more sustainable way of life. We currently have (2) distinct bio-based technology platforms. Green Boost™ is a bio-based adhesive additive that reduces the amount, while also enhancing the performance of the current traditional petrochemical based resins used today in the manufacture of composite wood panels. Green Ultimate™ is a unique bio-based adhesive solution that is free of petrochemical derived formaldehyde and isocyanate.

Contact:

Joe Lynch - General Manager, North America

Phone: 856-650-3660

Email: joe.lynch@evertree-technologies.com

727 Norristown Road, Building 3, Suite 105,
Ambler, PA 19002

www.evertree-technologies.com

Franklin Adhesives & Polymers

Franklin Adhesives & Polymers, a division of Franklin International, manufactures adhesives for wood furniture, millwork and engineered-lamination markets on a global scale. We have pioneered innovation in wood adhesives, developing adhesive solutions for many applications in the wood product manufacturing space. Under the trusted brand names Titebond, Multibond, ReaTITE and Advantage, our products provide superior performance in wood assembly, solid edge and face gluing, engineered product lamination and finger jointing. We don't just make adhesives -- we develop innovative solutions for the industry's biggest challenges.

Contact:

Audrey Albright, Technical Marketing Specialist, A&P

Phone: 614-445-1386

Email: audreyalbright@franklininternational.com

2020 Bruck Street, Columbus, OH 43207

www.franklinap.com



Fusoni

Fusoni develops and manufactures release agents and additives for panel board manufacturing, and also for paper impregnation processes. Our chemicals expertise extends to other industries, such as release applications in bakery, polyurethane systems, and other applications. For almost 40 years we have been serving clients in Europe, Asia, Africa, Australia and the Americas. We add value through chemistry, and work closely with our customers, helping them improve the properties of their products and reducing production cost through excellent release and additive performance. We look forward to working with you to make your products better and your business more profitable.

Contact:

Adrian Yovanovich - President

Phone: 210-712-7803

Email: ayovanovich@fusoni.us

422 Mesa Loop, San Antonio, TX 78258

www.fusoni.net

SILVER **Henkel**

Henkel is the world's largest Adhesive company. LOCTITE is a world leading brand in Polyurethane and Hybrid adhesives for engineered wood bonding, offering ductile bond lines, zero Formaldehyde, zero solvents with a wide range of open and set times for Glulam, CLT, Finger jointing, and innovative applications, both cold setting and RF/hot pressing. LOCTITE HB product lines are the only one-component polyurethane adhesive certified for high production adhesive certified to North American Glulam, CLT, Finger Jointing and I-Joist requirements. With a strong North American sales and technical team and a fully equipped wood lab, we can provide the solutions, support and technology to meet the demanding requirements of engineered wood bonding and innovations of the future.

Contact:

Ingrid Gagné – Sales Director, North America

Phone: 514-592-8579

Email: ingrid.gagne@henkel.com

2515 Meadowpine Blvd., Mississauga, Ontario L5N 6C3

Canada

www.henkel-adhesives.com

GOLD **Hexion Inc.**

Hexion Inc. is a leading global source for adhesives, resins, formaldehyde, melamine and derivatives serving a broad range of markets including the forest products, foundry, automotive, construction, composites, electronics and oilfield industries, operating more than 50 manufacturing plants in North America, Latin America, Europe and Asia/Pacific. The Forest Products division of Hexion Inc. is the global leader in supplying resins, adhesives, wax emulsions and ancillary products to the forest products industry. Customers use our materials to manufacture a wide range of composite and engineered wood products including plywood, particleboard, oriented strandboard, medium density fiberboard, structural beams, furniture, mouldings and millwork.

Contact:

Steve Banick - Senior Director NA Forest

Products, Resins

Phone: 541-741-6650

Email: steve.banick@hexion.com

180 East Broad Street, Columbus, OH 43215

www.hexion.com

Huntsman Polyurethanes

For more than 30 years, Huntsman has been a global leader in the production of MDI-based resin binders for particleboard, medium-density fiberboard and oriented strand board. Our dedicated Composite Wood Products teams are committed to helping our customers reach their goals in all market conditions. There is no added formaldehyde (NAF) with Huntsman's RUBINATE® resins, and can be qualified as exempt under CARB Standards and EPA TSCA Title VI.

Contact:

Richard Tyler - Business Manager

Phone: 470-303-3605

Email: richard_tyler@huntsman.com

10003 Woodloch Forest Drive

The Woodlands, TX 77380

www.huntsman.com

GOLD IPCO

IPCO is the largest manufacturer of continuous solid stainless steel press belts in the world. Our steel belts are custom made to specific tolerances for each continuous double belt press. We also offer a full complement of repair tools and world class service to keep your press up and running quality product.

Contact:

Craig Bartsch - Global Sales Manager

Phone: 201-723-0297

Email: craig.bartsch@ipco.com

10A Bloomfield Avenue, Suite 8, Pine Brook, NJ 07058

www.ipco.com

MÜNZING

CREATING ADDITIVE VALUE

MÜNZING

MÜNZING FENTAK® specialty additives are designed for use in the wood processing industry. The products are used in a number of applications, including decorative and industrial laminates, wood panels and engineered wood. All products are specifically designed to either help enhance the properties or appearance of the final product or improve the production process. Standard products include release agents, wetting agents, resin catalysts and dyes as well as more specialized products such as plasticizers and surface modifiers.

Contact:

Daron Alcorn - West Coast Sales Representative

Phone: 503-475-4616

Email: d.alcorn@munzing.com

1455 Broad St., Bloomfield, NJ, 07003

www.munzing.com

OCI Melamine Americas

OCI Melamine is a supplier of melamine. Melamine is used in the manufacture of formaldehyde-based resins commonly found in decorative surfaces, OSB, plywood, MDF boards and others.

Contact:

Rhonda Pizzolato - Customer Service

Phone: 800-615-8284

Email: rhonda.pizzolato@ocimelamine-all.com or info.melamine@ocinitrogen.com

c/o Advanced Louisiana Logistics - ALL

501 Louisiana Avenue, Suite 201

Baton Rouge, LA 70802

www.ocimelamine.com

Paneltech

Paneltech is a young and growing, forward-thinking company comprised of people who have common values and share a common goal...providing environmentally responsible leadership in manufacturing the best performing products for industry. Our panel overlays are designed for high performance end uses and superior processability. They are designed to increase the value of the wood products they cover by increasing their durability, enhancing their appearance, and creating uniform surfaces to enhance the product's end use.

Contact:

David Wentworth - General Manager

Phone: 360-538-1480

Email: dwentworth@paneltechintl.com

2999 John Stevens Way, Hoquiam, WA 98550

www.paneltechintl.com

Sansin Corporation (The)

Backed by over 35 years of proven performance with large commercial, residential and mass timber wood buildings and structures, Sansin is the global leader in developing high-performance factory finishes that deliver the color, durability and performance that architects, engineers and builders can count on. From undercoats, treatments and preservatives to finishes and fire retardant coatings, Sansin's Precision Coat products provide wood protection for a variety of substrates and engineered wood products, including cross-laminated timber, siding, OSB, glulam, millwork and timbers - delivering unparalleled beauty and durability in environmentally friendly formulas. New locations in Europe and the United States.

Contact:

Ann Van Dyk

Phone: 519-245-2001

Email: ann@sansin.com

111 MacNab Ave, Strathroy, ON N7G 4J6 Canada

www.sansinfactoryfinish.com

SASCO Chemical, A PSG Company

Polymer Solutions Group is an innovative manufacturer of proprietary and custom polymer additives, dispersions, and performance chemicals for the rubber, wood, consumer, construction, and medical industries. SASCO's TechKote® Release Agents, Additives, and Platen Conditioners are chemically formulated for all composite and structural panel applications. Together we strive to deliver customer-centric solutions that improve our customers' products, processes and performance.

Contact:

Clancy Redmond - Director of Sales and Business Development

Phone: 229-435-8394

Email: credmond@polymersolutionsgroup.com

827 Pine Avenue, Albany, GA 31701

www.polymersolutionsgroup.com

Shurtape Technologies, LLC

Shurtape Technologies, LLC, is a global leader in adhesive tape manufacturing, serving industrial, consumer, and professional markets. With facilities across the U.S., Europe, Latin America, Australasia, and Asia, Shurtape delivers best-in-class, pressure-sensitive adhesive solutions, including high-performance acrylic membranes (flashing, seam sealing, weather resistant barriers) for construction and remodeling.

Our portfolio includes trusted brands like Duck®, FrogTape®, Painter's Mate®, Shurtape®, T-Rex®, Kip®, and Pro Tapes®.

Contact:

Charlie Robinson – Director, Business Development

Phone: 704-999-2603

Email: chrobinson@shurtape.com

1712 8th Street Drive SE, Hickory, NC 28602

www.shurtapetech.com

Siemer Milling

Siemer Millings produces and markets Glu-X. Glu-X is an All-Natural Chemical Free special glue extender milled from wheat and used expressly as the protein-starch adhesive for the wood panel (plywood) industry. This proprietary product was developed from the trade secret processes with the contributions of plywood manufacturers, master millers, adhesive scientists and cereal chemists.

Contact:

Jay Wallace - Vice President of Customer Service

Phone: 271-857-2240

Email: jwallace@siemermilling.com

111 W. Main Street, Teutopolis, IL 62467

www.siemermilling.com

Stratachem Solutions Group LP

Stratachem Solutions Group LP provides chemical solutions specifically for the wood products industry. With over 50 years of technical wood products experience, and a world class research and development group, we are prepared to take on tough process issues. We specialize in release agents for continuous and multi-opening presses, as well as environmental equipment chemical solutions. WESP water treatment chemistry, to keep WESPs and RTOs running up to design capacities. We are dedicated to customer satisfaction and understand the importance maintaining the highest levels of process efficiency while decreasing the cost of manufacturing.

Contact:

Mike Larke - General Manager

Phone: 866-489-9377

Email: mlarke@stratachemsolutions.com

#155 513 Memorial Blvd., Springfield, TN 37219

www.stratachemsolutions.com

SILVER Walker Emulsions

Walker Emulsions is a supplier of high quality, highly effective emulsions for the wood composite industry. We have a selection of emulsions that will fit the needs of high to low temperature pressing and we can make products specifically to match your process.

Contact:

Charles Stout - Eastern North America

Phone: 803-747-0045

Email: cstout@walkerind.com

Corporate Office:

2800 Thorold Townline Road,

Niagara Falls, ON L2E 6S4, Canada

www.walkerind.com

DIAMOND Wanhua Chemical (America) Co., Ltd.

Wanhua Chemical is the fastest growing and largest MDI producer globally with best-in-class technology and world-leading state-of-the-art manufacturing sites producing WANNATE® PMDI binder solutions to customers and partners in the Composite Wood Panel industry. Wanhua Chemical is renowned for its high quality WANNATE products and dependable supply chain that Composite Wood Panel producers depend on. Wanhua Chemical has worldwide operations with a local commitment to customers, including ongoing investments in technical resources and infrastructure in North America, further strengthening Wanhua's technical service and supply commitments to the Composite Wood Panel industry.

Contact:

Melissa Gutzler – Business Support Analyst

Phone: 610-331-4096

Email: melissa.gutzler@us.whchem.com

3803 West Chester Pike, Suite 125

Newton Square, PA 19073

www.whchem.com



Go to the online Materials and Supplies directory for additional details.

PLATINUM

The Willamette Valley Company

The Willamette Valley Company (WVCO) manufactures defect repair products for upgrading all wood substrates, and also makes a wide range of water based coatings, primers and sealers. WVCO also manufactures fillers and extenders for wood product adhesives, along with wax products and inks for our customer needs. PRE-TEC, the company's equipment solutions division, specializes in design and manufacturing of advanced fluid systems and the integration of robotic application systems.

Contact:

Robert Pitts, Executive Vice President, Global Wood Division

Phone: 800-333-9826

Email: robert.pitts@wilvaco.com

990 Owen Loop North, Eugene, OR 97402

www.wilvaco.com

STRENGTH THROUGH CONNECTIONS

EWTA Welcomes New Members

Shurtape Technologies, LLC, is a global leader in adhesive tape manufacturing, serving industrial, consumer and professional markets. With facilities across the U.S., Europe, Latin America, Australasia and Asia, Shurtape delivers best-in-class, pressure-sensitive adhesive solutions, including high-performance acrylic membranes (flashing, seam sealing, weather resistant barriers) for construction and remodeling. Our portfolio includes trusted brands like Duck, FrogTape, Painter's Mate, Shurtape, T-Rex, Kip, and Pro Tapes.



Contact:

Charlie Robinson – Director, Business Development

Phone: 704-999-2603

Email: chrobinson@shurtape.com

Additional details are available at www.shurtapetech.com

WPS Industries / Eagle Project Services

WPS Industries is a full-service fabrication and installation



provider for Wood Products, Biomass, Oil & Gas, Environmental, Power and various other industries. Eagle Project Services provides detailed engineering and project management services to the same noted industries.

Contact:

Jeremy Clark – Business Development

Phone: 318-243-0862

Email: Jeremy.clark@iss-na.com

Additional details are available at www.iss-na.com

Continues on next page.

AFRY Welcomes New Head of Wood Products

Dr. Thomas Walther recently joined AFRY to head the Wood Products expertise area, succeeding Frank Goecke, who will join SEEMAC as president and CEO. Congratulations to both!

Walther brings a wealth of experience in the wood products industry to his new role, having worked extensively with clients across the globe. He holds a Ph.D. in Wood Science and Technology from Hamburg University in Germany and is highly regarded for his expertise in wood product innovation, research and development.

In his new position, Walther will oversee all aspects of AFRY Management Consulting's Wood Products expertise area, which includes advising clients on market trends, supply chain optimization, cost efficiency strategies and innovation opportunities.

Before joining AFRY, he spent 13 years at Swedspan and IKEA Industry in Sweden, where he led the product development of wood-based panels, lightweight constructions and sustainable adhesive systems. Walther combines deep production expertise with the capability to scale concepts from inception to full industrialization.

Con-Vey Unveils New Brand and Website

Con-Vey has announced the launch of its new brand and website. The transformation reflects the company's commitment to innovation and its focus on bringing its clients, team and community into a future full of possibilities.



CON-VEY

Continues on next page.

We bridge your DREAMS.

Hashimoto

Dry Veneer Composer

Falling short of a standard is not our concept. By enhancing production efficiency and providing excellence in quality, **HASHIMOTO** leads the industry in technology.

Example of stacking composed veneers



4Ft. & 10Ft. Veneer Composer are also available.



Example of defect cutting of veneers



8Ft. Veneer Clip Scan Analyzer + Veneer Composer

Hashimoto Denki Co., Ltd.

overseas.trade@hdk-co.com
<https://www.hdk-co.com/en/>



Con-Vey's evolved brand is centered around the company's mission of Velocity, which is prominently represented in the website's engaging content and visuals.

"Since our inception in 1946, Con-Vey has continually evolved to better serve our clients and drive innovation in the industry. While our brand is new, our commitment to building lasting solutions with our clients remains unchanged," said Dave Larecy, president & CEO at Con-Vey.

The new website offers a comprehensive look at who Con-Vey is, what their team values and the solutions that make them a trusted partner in the manufacturing industry. Visitors can explore detailed information on Con-Vey's services, projects and the company's approach to pushing the boundaries of what's possible.

Experience the new Con-Vey at www.con-vey.com

Dürr screw spindle replaces piston drive

Dürr is expanding its product line with the EcoMeter SP, a continuous dosing system designed for the seamless application of highly viscous media without interrupting material flow. This product is well-suited for large-volume applications that require substantial amounts of adhesives or sealants. A screw spindle pump drives the continuous dosing system, making it lighter and more compact, lower maintenance, and more cost-effective than previous alternatives.

Three screw spindles deliver uninterrupted and continuous material feed. An electric servo motor drives the middle spindle, initiating movement in the other two. The connected supply station holds the material. These spindles rotate in opposition to push the material into the endless dosing system's applicator.

The EcoMeter SP is not a replacement but a complementary addition to the proven EcoShotMeter models with piston drive, which are ideal for

applications that require high pressure, high volumetric flows and utmost precision. Dürr's EcoMeter SP is available immediately in two versions: one for direct applicator mounting on the dosing unit and one for mounting the applicator using a hose so it is decoupled from the dosing unit. The endless dosing system is also suitable for large-volume industrial bonding applications using both 1C and 2C materials.

Visit www.durr.com/en for additional details.

Kadant Solutions Division Launches the X-Tek™ Roll Cleaning Blade

Kadant Solutions Division, a division of Kadant Inc., recently announced the launch of the X-Tek roll cleaning blade, a cutting-edge solution designed for high-temperature cleaning applications with highly polished roll surfaces such as those found in carbon fiber and lithium-ion battery production.

"The new X-Tek roll cleaning blade incorporates both polymeric and carbon fibers," stated Dr. Ka Lun To, senior blade manufacturing and R&D manager for Kadant U.K. Limited, a subsidiary of Kadant Inc. "This unique combination provides highly effective roll cleaning while ensuring the roll surface is not damaged, an issue that can occur with traditional metal or glass fiber blade materials."

The thin X-Tek roll cleaning blade is engineered with multiple layers of polymeric and carbon fibers. Its advanced construction allows the blade to quickly conform to the roll surface, ensuring a thorough cleaning process. The blade materials and construction reduce manufacturing downtime and maintenance costs in high-temperature roll cleaning applications due to durable carbon layers, which provide extended blade life and a reliable cleaning solution.

For more information, visit www.kadant.com.

Continues on next page.



IMEAS

THE LEADING SANDER SUPPLIER IN ENGINEERED WOOD

Scan To
Learn More



INFO FAIR
BOOTH
#503



We can run up to about 180 panels per hour through it and still hold all our tolerances.

From start-up, we were running within a couple days of actually getting it set down.

RAMY WEAVER | PACIFIC WOOD LAMINATES



IMEAS Inc. 1415 Senoia Road, Suite A Tyrone, Georgia 30290 | (678) 364-1900 | imeas@imeas.net | imeas.us

SEAL & SAFE STRAPPING

INFO FAIR
BOOTH
#513

Leveraging decades of expertise, **Itipack Systems** brings cutting-edge strapping solutions, built with electrical gear motor driven platen press systems to maximize efficiency and prioritize safety.

Our Applications:

- Wood panels
- Dimensional wood
- Engineer wood



Raute's fully owned Hiottu Oy to be merged into Raute Corporation

Raute's Board of Directors has approved a merger plan according to which the company's wholly owned subsidiary Hiottu Oy will be merged into Raute Corporation. The merger is expected to take place on December 31, 2024.

Raute Corporation acquired 80% of the shares of Hiottu Oy in 2020 and redeemed the remaining 20% in 2023. Hiottu Oy has brought strong digitalization expertise to Raute, especially in machine vision and AI solutions. The objective of the merger is to simplify the Group structure to increase business efficiency.

Hiottu, founded in 2005, specializes in software development for industrial applications. The company is located in Oulu, Finland, and has gained

a reputation for providing advanced solutions in areas like machine vision, industrial software, and web programming. Hiottu's services are particularly tailored to meet the needs of industrial clients, helping them optimize production processes, enhance safety and improve quality control.

Visit www.raute.com for more information.

2025 APA ANNUAL MEETING AND EWTA INFO FAIR

APA | EWTA



Save the Date!

October 4-7, 2025

Sheraton Grand at
Wild Horse Pass,
Phoenix, AZ

JARDAR SYSTEMS, INC.

AIR POLLUTION CONTROL SPECIALISTS

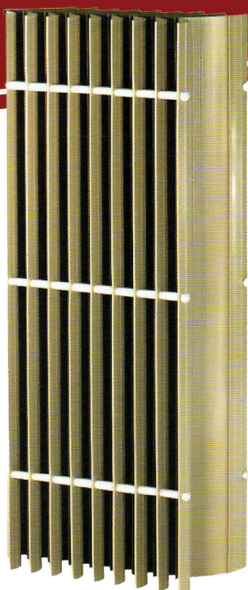

HALF-WAVE VANES

proprietary high-performance mist eliminators incorporating engineered drain channels and troughs

- High Efficiency design eliminates free water droplet carryover reducing RTO gas usage
- Reduce particulate buildup in downstream ductwork & exhaust fans
- Positive fastening of front and trailing edges eliminates vane fatigue
- Reduced corrosion on RTO media and internals
- Modular vane pack design for easy installation

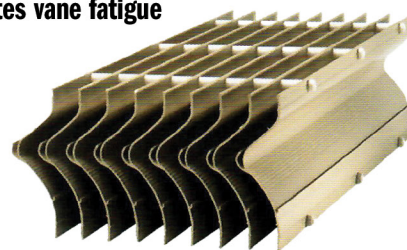

info@jardarsystems.com | jardarsystems.com

UPCOMING 2024 EWTA EVENTS

September 25-27, 2024

Timber Processing & Energy Expo (TP&EE)

Portland Expo Center, Portland, Oregon

Stop by booth #134 and say hello!

September 28

EWTA Advisory Committee Meeting

JW Marriott San Antonio Hill Country
Resort & Spa

10:30-11:30 a.m. - Cibolo 3-4

September 28 – Oct. 1

APA Annual Meeting and EWTA Info Fair

JW Marriott San Antonio Hill Country Resort &
Spa, San Antonio, Texas



MICRONETIXX Technologies
Engineered Wood High-Power Microwave Systems

*Micronetixx High-Power Engineered Wood
Microwave Pre-Heating Systems - In Operation*

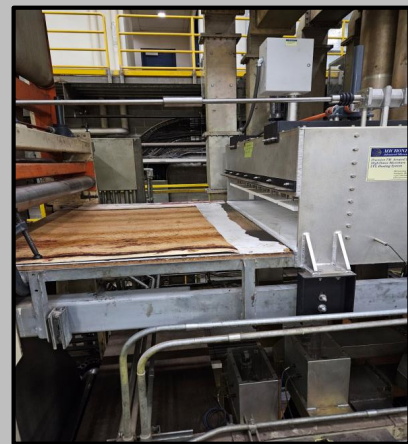
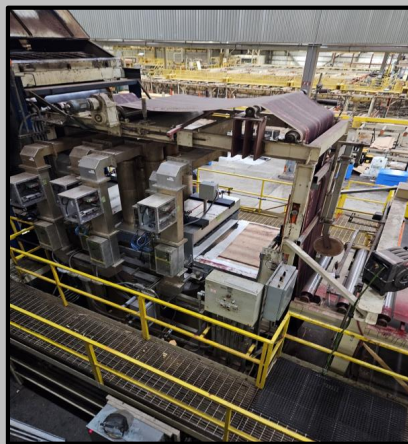

Micronetixx High-Power Engineered Wood Microwave Pre-Heating Systems: Enormous Increases in Efficiency, Yield and Quality. (*ADAPTABLE TO CYCLE PRESSES ALSO*)

Micronetixx Technologies, LLC

Lewiston, Maine 04240 USA

Website: www.micronetixx.com

Email: info@micronetixx.com Voice: +(207) 786-2000; Fax: +(207) 786-7444



ADDITIVE SOLUTIONS FOR THE LAMINATE & WOOD PROCESSING INDUSTRY

Additives for Wood Panels /
Engineered Wood
Manufacturing

Additives for Laminate
Manufacturing

INFO FAIR
BOOTH
#302



FENTAK®
PROCESSING ADDITIVES

MUNZING's worldwide
production network of
manufacturing plants in
Germany, USA, Australia
and Malaysia, facilitate
supply and prompt
delivery wherever our
customers do business

www.munzing.com

READER SERVICES

EWTA and *Engineered Wood Journal* contact information

Mail: 7011 So. 19th St., Tacoma, WA 98466-5333

Phone: 253 620-7483

Email: ewta@engineeredwood.org

Article reprint permission.

Send your request in writing to the Editor at the email or address listed above.

Current and past *Engineered Wood Journal* issues.

Go to: www.engineeredwood.org/engineered-wood-journal

EWTA membership and/or Info Fair exhibiting information.

Contact LaDauna Wilson, 253 620-7483,
ewta@engineeredwood.org.

APA member product questions or assistance.

Contact the APA Product Support Help Desk,
253 620-7400, help@apawood.org

Mailing and membership lists.

Mailing lists for this publication are not available. For a listing of members of EWTA, visit www.engineeredwood.org. For a listing of APA members, visit www.apawood.org.

EVERGREEN ENGINEERING®, INC.

INFO FAIR
BOOTH
#212

- Engineered Wood
- Material Handling
- Boiler Systems
- Preliminary & Detail Engineering
- Project & Construction Management
- Permit Coordination
- Feasibility Studies
- EPC Teaming



888-484-4771

Everett, Washington • Eugene, Oregon • Atlanta, Georgia



Visit our website at
EvergreenEngineering.com

EQUIPMENT AND TOOLING

- Altec Integrated Solutions 41**
Controls, Electronics, Optimization, Automation/
Grading, Scanning/Panel Repair, Patching
www.alteconline.com
- HASHIMOTO DENKI Co., Ltd. 87**
Panel Production Equipment/Primary Processing Equipment/
Veneer Processing and Drying
www.hdk-co.com
- IMEAS, Inc. 89**
Sanding and Finishing Equipment
www.imeas.us
- Itipack Systems 89**
Wrapping, Strapping and Packaging /
Strapping and Packaging Supplies
www.itipacksystems.com
- Jardar Systems, Inc 90**
www.jardarsystems.com
- LEDINEK 4**
Accessory Tools and Equipment/Custom and Tooling Equip-
ment/Finish Line Systems/Primary Processing Equipment
www.ledinek.com
- Micronetixx Technologies, LLC 91**
www.micronetixx.com
- USNR 45**
Controls, Electronics, Optimization, Automation/Grading,
Scanning/Hydraulics, Hydraulic Systems/Panel Production
Equipment/Veneer Processing and Drying
www.usnr.com
- The Willamette Valley Company 47**
Controls, Electronics, Optimization, Automation/ Grading,
Scanning/Labeling, Marking/ Finishing Line Systems/ Panel
Repair, Handling and Wrapping Equipment
www.wilvaco.com

MATERIALS AND SUPPLIES

- Arxada 2**
Chemicals/Additives/Coatings
www.wolmanizedwood.com
- Bostik 36-37**
Adhesives/Resins
www.bostik.com
- Münzing 92**
Wax, Release Agents, Lubricants, Emulsions/ Chemicals,
Additives, Coatings
www.munzing.com
- The Willamette Valley Company 47**
Binders, Extenders, Fillers/Wax, Release Agents,
Lubricants, Emulsions/ Replacement Parts and Supplies/
Chemicals, Additives, Coatings
www.wilvaco.com

CONSULTING AND SERVICES

- Evergreen Engineering 92**
Engineering Services
www.evergreenengineering.com
- LEDINEK 4**
Plant Design and Construction/Industrial
Construction and Installation/Engineering Services
www.ledinek.com
- Mid-South Engineering 8**
Plant Design and Construction/Industrial Construction and
Installation/Engineering Services/Maintenance, Inspection/
Project Management
www.mseco.com

PRODUCT SHOWCASE



With the addition of Ventek’s veneer scanning, grading, and handling solutions to USNR’s lathe, dryer, and downstream product portfolio, USNR now offers tightly integrated mechanical and optimization solutions for the plywood industry. USNR products are known to increase recovery, value, and yield, improving mill profitability. USNR also manufactures machinery for beam lamination, finger-jointing, and presses for the composite board industry. Committed to superior customer service, USNR offers OEM parts, training, and 24/7 support around the globe. 800-BUY-USNR.

Contact:

Chris Van Ackeren – Senior EWP Account Manager
Phone: 541-284-5465
Email: Chris.vanackeren@usnr.com
1981 Schurman Way (PO Box 310) Woodland, WA 98674
www.usnr.com

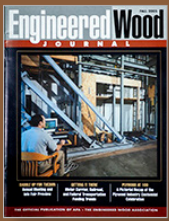
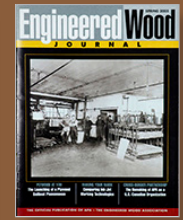

Engineered Wood Journal
1998-2024